

ML4D/ML2D

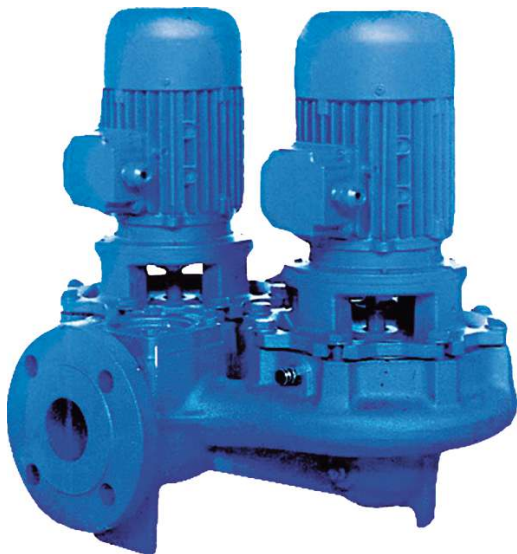

GENERALITÀ / FEATURES

Serie di pompe centrifughe monoblocco in ghisa con bocche "in line", ed esecuzione gemellare, per portate fino a 210 m³/h e prevalenze fino a 62 metri, accoppiata direttamente al motore normalizzato con lanterna e giunto rigido.

It's a series of centrifugal cast-iron pumps with in-line bores and twin execution, for capacity up to 210 m³/h and head up to 62 m, directly coupled to the standardized motor with bracket and rigid joint.

MATERIALI / MATERIALS

- Corpo pompa e girante: ghisa
- Albero: acciaio
- Tenuta meccanica: Carbone/silicio/EPDM
- *Casing and impeller: cast-iron*
- *Shaft: stainless steel*
- *Mechanical seal: EPDM/silicon carbide*

MOTORE / MOTOR

- Asincrono trifase 1450 giri/min (ML4) o 2900 giri/min (ML2), costruito per servizio continuo
- Grado di protezione: IP55
- Isolamento classe F
- Alimentazione trifase 230/400V 50Hz per potenze fino a 5,5 kW; 400/690V per potenze oltre 5,5 kW
- *Asynchronous, three-phase 1450 rpm (ML4) or 2900 rpm (ML2) continuous duty*
- *Protection degree: IP55*
- *Insulation class F*
- *Three-phase feeding: 230/400V 50Hz for powers up to 5,5 kW; 400/690V for powers over 5,5 kW*

LIMITI DI IMPIEGO / OPERATING CONDITIONS

- Pressione massima di esercizio: 10 bar per ML 50-65-80, 6 bar per ML 40-100
- Temperatura del liquido movimentato: -10°C/+130°C
- *Max. working pressure: 10 bar for ML 50-65-80, 6 bar for ML 40-100*
- *Max. liquid temperature: -10°C/+130°C*

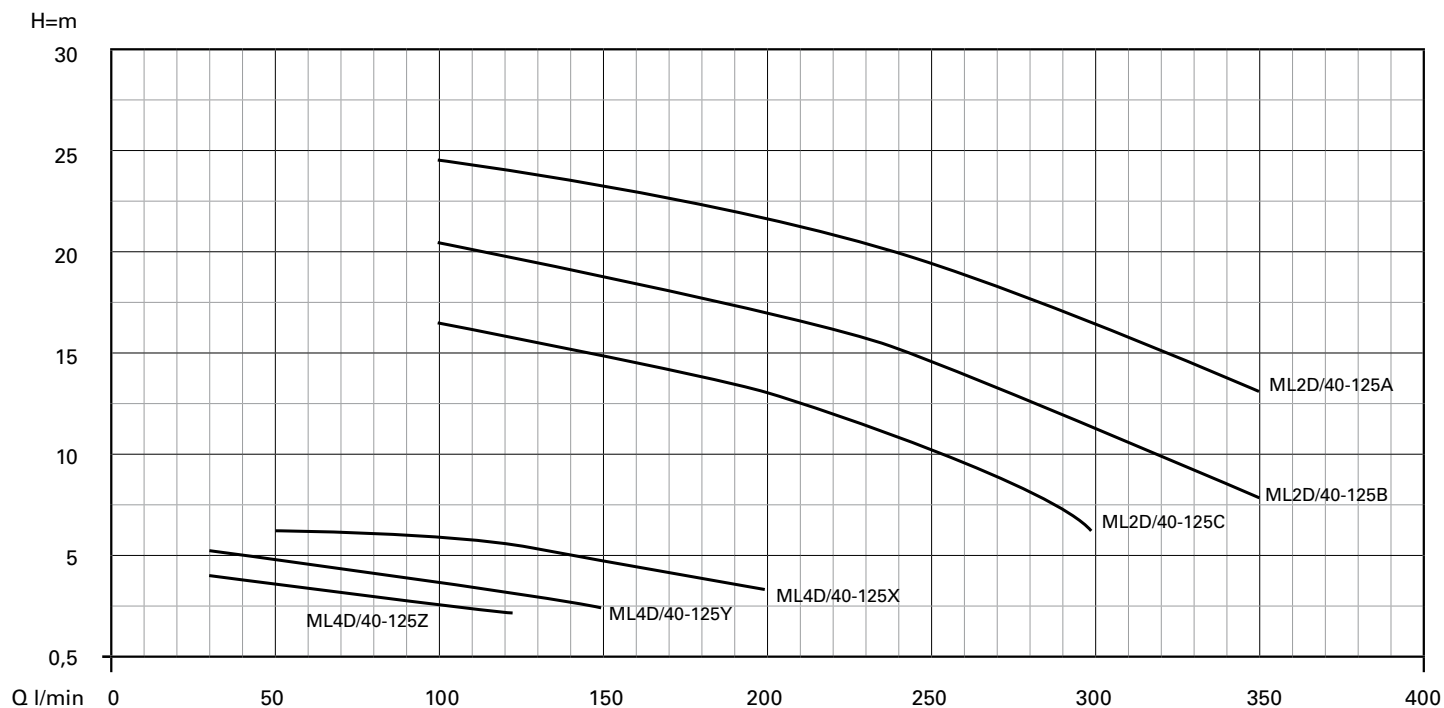

Modello <i>Model</i>	Poli <i>Poles</i>	P2 kW	A		Q=Portata - <i>Capacity</i>												
					l/min	30	50	75	100	125	150	175	200	225	250	300	350
					m ³ /h	1,8	3	4,5	6	7,5	9	10,5	12	13,5	15	18	21
					Prevalenza manometrica totale in m C.A. - <i>Total head in meters w.c.</i>												
ML4D/40-125Z	4	0,25	1,9	1,1	3,8	3,6	3,1	2,6	1,9								
ML4D/40-125Y	4	0,25	1,9	1,1	4,7	4,5	4,1	3,6	3	2,2							
ML4D/40-125X	4	0,25	1,9	1,1		6,2	6,0	5,8	5,2	4,5	3,9	3					
ML2D/40-125D	2	0,75	3	1,7				12,5	11,5	10,5	9,3	8,1	6,8	5,2			
ML2D/40-125C	2	0,75	3,3	1,9				16,5	15,5	14,5	13,5	12,3	11	9,5	6,0		
ML2D/40-125B	2	1	4,4	2,2				20,5	20	19	18	17	16	15	11,5	7,5	
ML2D/40-125A	2	1,5	6,2	3,6				24,5	24	23,5	23	22	21	20	16,5	13	

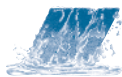

ML4D/ML2D

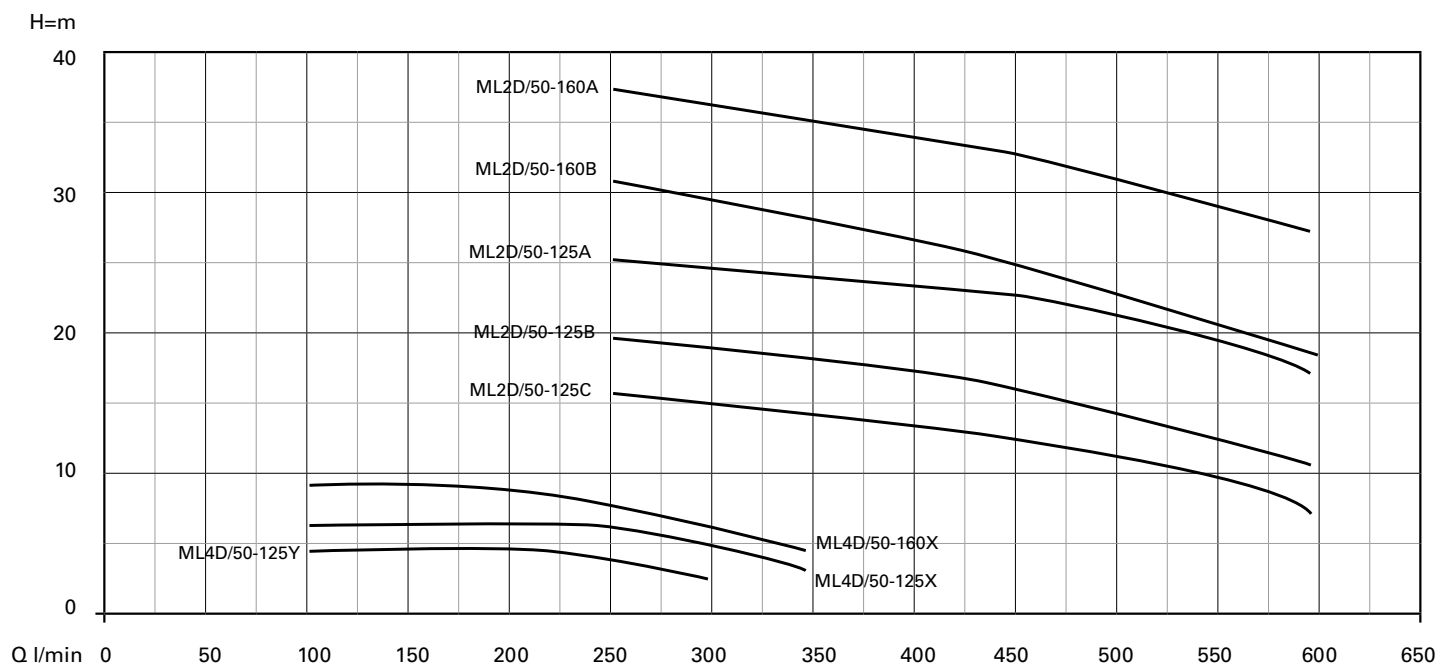

Modello <i>Model</i>	Poli <i>Poles</i>	P2 kW	A		Q=Portata - <i>Capacity</i>													
					l/min	100	125	150	175	200	225	250	300	350	400	450	500	600
					m³/h	6	7,5	9	10,5	12	13,5	15	18	21	24	27	30	36
					Prevalenza manometrica totale in m C.A. - <i>Total head in meters w.c.</i>													
ML4D/50-125Y	4	0,25	1,9	1,1	4,6	4,5	4,3	4,1	3,9	3,6	3,3	2,4						
ML4D/50-125X	4	0,37	2	1,15	6,3	6,2	6,1	6	5,8	5,5	5,2	4,6	3					
ML4D/50-160X	4	0,5	2,8	1,6	8,8	8,6	8,3	8	7,7	7,3	6,9	5,9	4,5					
ML2D/50-125C	2	1,5	6,2	3,6							15,5	15	14,1	13	11,8	10,5	7	
ML2D/50-125B	2	2	7,7	4,4							19	18,5	17,5	16,5	15,5	14,5	10,5	
ML2D/50-125A	2	3	11	6,4							24,5	24	23,5	23	22	20,5	17	
ML2D/50-160B	2	3	11	6,4							30	29	28	26,5	25	23	18	
ML2D/50-160A	2	4	15,3	8,8							36,5	35,5	34,5	33,5	32,5	31	27	

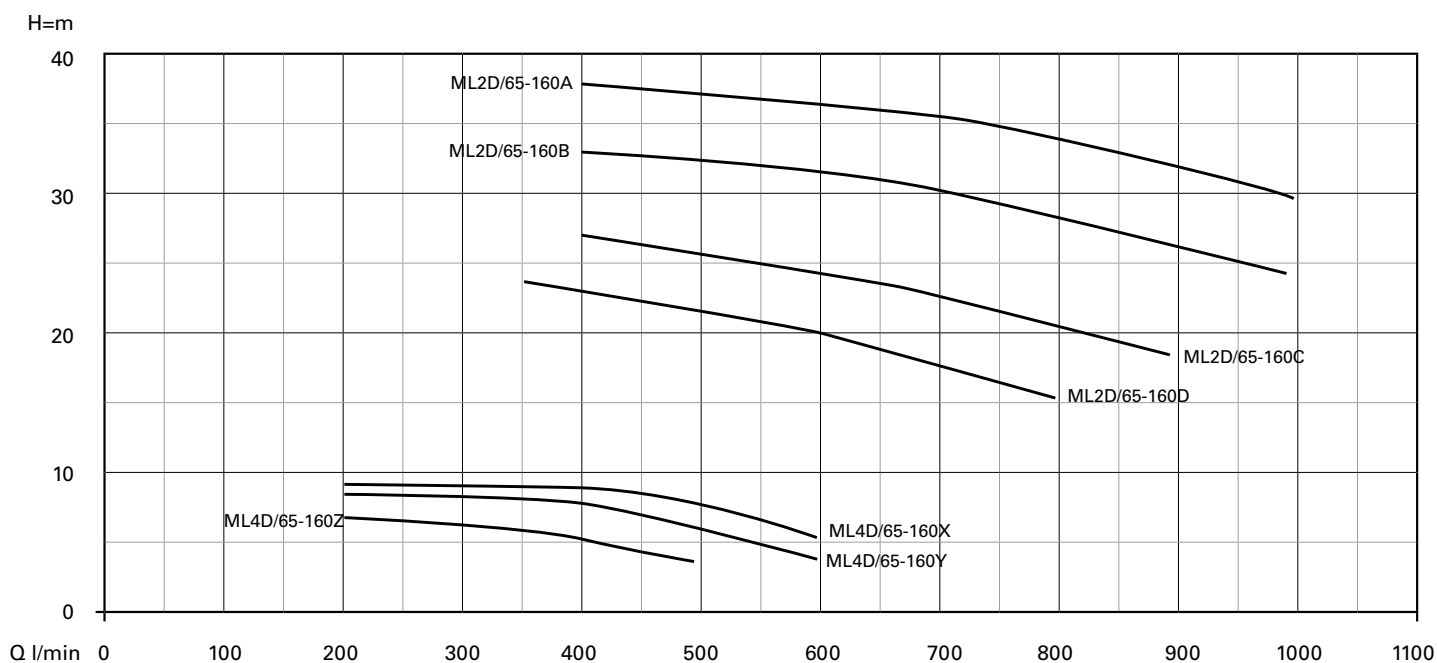
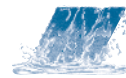

Modello <i>Model</i>	Poli <i>Poles</i>	P2 kW	A		Q=Portata - <i>Capacity</i>													
					l/min	200	225	250	300	350	400	450	500	600	700	800	900	1000
					m ³ /h	12	13,5	15	18	21	24	27	30	36	42	48	54	60
			3x230	3x400	Prevalenza manometrica totale in m C.A. - <i>Total head in meters w.c.</i>													
ML4D/65-160Z	4	0,55	2,7	1,6	6,7	6,6	6,4	6,1	5,7	5,1	4,3	3,3						
ML4D/65-160Y	4	0,75	3,5	2	8,2	8	7,9	7,7	7,4	7	6,6	6	4					
ML4D/65-160X	4	0,9	4,2	2,4	9	8,9	8,8	8,6	8,4	8,1	7,7	7,2	5,5					
ML2D/65-160D	2	3	11	6,4					23	22,5	22	21,5	19,8	17,5	15			
ML2D/65-160C	2	4	15,3	8,8						26,5	26	25,5	24,3	20,2	20,2	18		
ML2D/65-160B	2	5,5		11,3						32,5	32	31,5	30,5	28	28	26	23,5	
ML2D/65-160A	2	7,5		12,8						37	36,5	36	35	32,5	32,5	31	29	

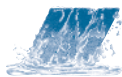

ML4D/ML2D

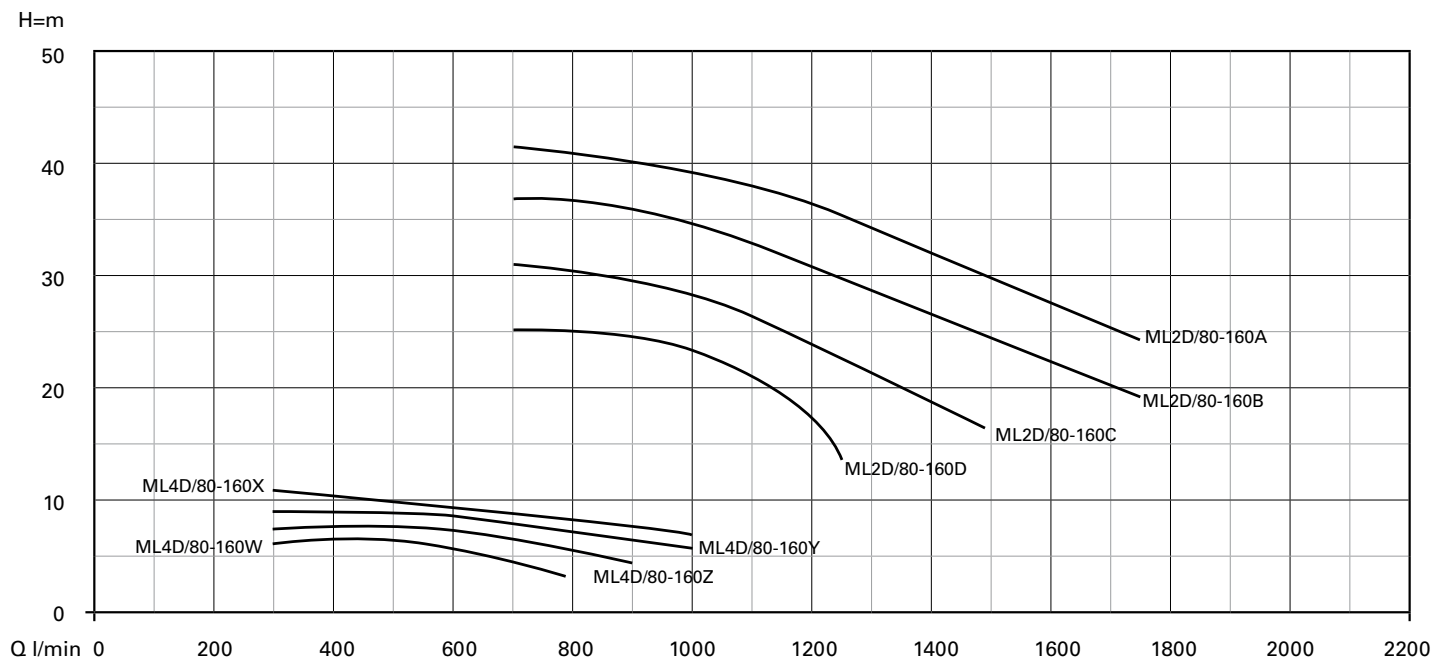

Modello <i>Model</i>	Poli <i>Poles</i>	P2 kW	A		Q=Portata - <i>Capacity</i>															
					l/min	300	350	400	450	500	600	700	800	900	1000	1100	1200	1250	1500	1750
					m³/h	18	21	24	27	30	36	42	48	54	60	66	72	75	90	90
Prevalenza manometrica totale in m C.A. - <i>Total head in meters w.c.</i>																				
ML4D/80-160W	4	0,75	3,9	3	6,3	6,2	6,1	5,9	5,6	4,9	4,1	3,2								
ML4D/80-160Z	4	0,9	4,7	2,7	7,3	7,2	7,1	7	6,8	6,3	5,6	4,8	3,9							
ML4D/80-160Y	4	1,1	4,5	2,6	8,6	8,5	8,4	8,3	8,2	8	7,5	6,8	6	5						
ML4D/80-160X	4	1,5	6,2	3,6	10,2	10,1	10	9,9	9,8	9,4	9	8,5	7,7	6,5						
ML2D/80-160D	2	7,5		17,5							25	24,9	24,1	23,4	20,5	17	12,7			
ML2D/80-160C	2	10		22,7							30,5	30	29,5	29	26,5	24	20,5	16		
ML2D/80-160B	2	12,5		27,2							36,5	36	35,5	34,5	33	30	27	23	19	
ML2D/80-160A	2	15		32,2							41	40,5	40	39,5	38	35,5	33	29	24	

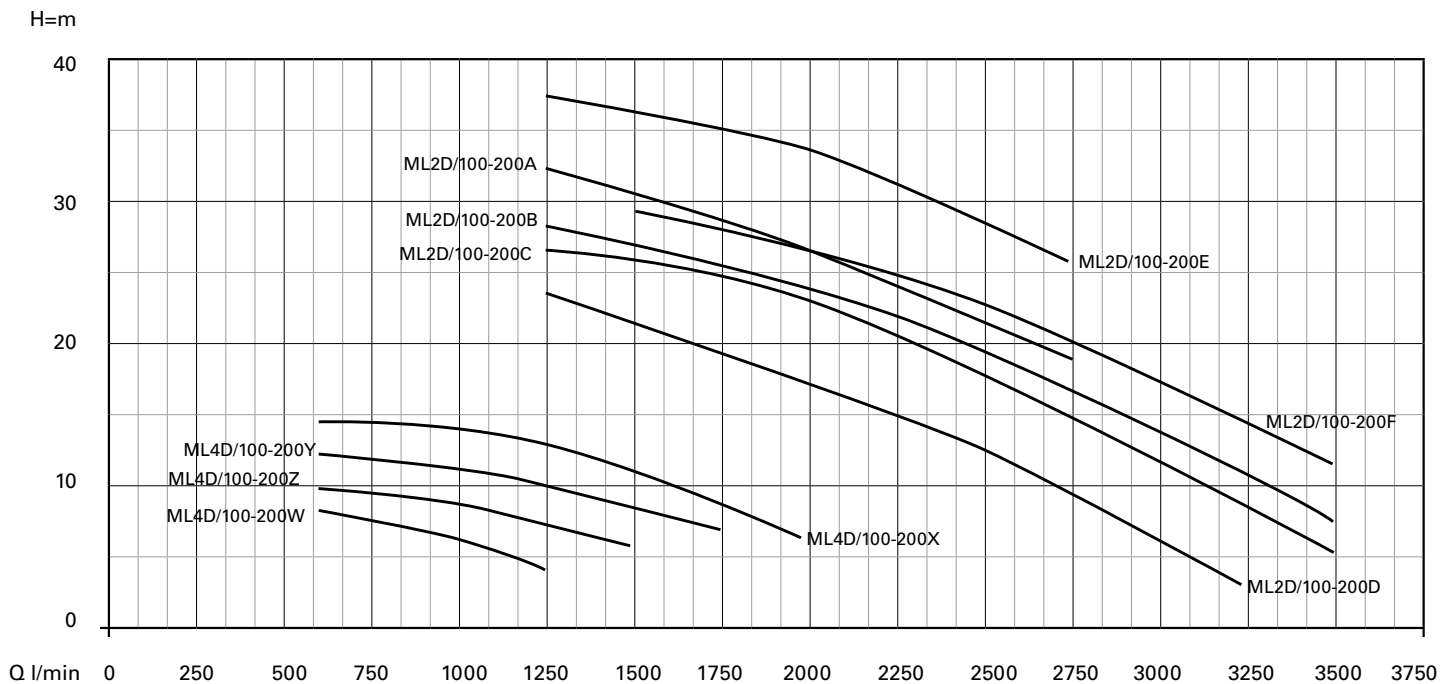
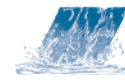

Modello <i>Model</i>	Poli <i>Poles</i>	P2 kW	A		Q=Portata - <i>Capacity</i>																	
					Prevalenza manometrica totale in m C.A. - <i>Total head in meters w.c.</i>																	
					l/min	600	700	800	900	1000	1100	1200	1250	1500	1750	2000	2250	2500	2750	3000	3250	3500
					m ³ /h	36	42	48	54	60	66	72	75	90	105	120	135	150	165	180	195	210
			3x230	3x400																		
ML4D/100-200W	4	1,5	6,2	3,6	7,8	7,4	7	6,5	6	5,3	4,6	4										
ML4D/100-200Z	4	2,2	7,7	4,4	10	9,7	9,3	8,9	8,5	8	7,5	7	6									
ML4D/100-200Y	4	3	11	6,4	12	11,7	11,5	11,3	11	10,5	10	9,5	8,5	7								
ML4D/100-200X	4	4	15,3	8,8	14,5	14,2	14	13,8	13,1	13,1	12,7	12,2	11	9	6,5							
ML2D/100-200D	2	10		22,7								23,3	22	20,5	18,5	16	13,5	10,5	7	3		
ML2D/100-200C	2	12,5		27,2								26,2	25,5	24	22	20	17,5	15	12	8,6	5	
ML2D/100-200B	2	15		32,2								27,8	27	25,5	23,5	21,5	19	16,5	13,8	10,8	7,5	
ML2D/100-200A	2	15		32,2										29	28	26	24,5	22	20	17,5	14	11,3
ML2D/100-200F	2	12,5		27,2								32,1	31	29	27	24,5	22	19				
ML2D/100-200E	2	15		32,2								37,3	36,5	35	33	31	28,5	26				

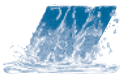

ML4D/ML2D

MODELLO POMPA PUMP'S MODEL	DIMENSIONI POMPA mm PUMP'S DIMENSIONS mm											PESO WEIGHT kg	DTA DTM	DNA DNM	FLANGE mm FLANGES mm				
	A	B	C	D	E	F	G	H	I	L	M				1	2	3	4	5
ML4D/40-125Z	425	100	325	397	200	197	340	130	210	20	100	41	G 1"1/2	40PN10	88	110	150	4	18
ML4D/40-125Y	425	100	325	397	200	197	340	130	210	20	100	41	G 1"1/2	40PN10	88	110	150	4	18
ML4D/40-125X	425	100	325	397	200	197	340	130	210	20	100	41	G 1"1/2	40PN10	88	110	150	4	18
ML2D/40-125D	425	100	325	397	200	197	340	130	210	20	100	50	G 1"1/2	40PN10	88	110	150	4	18
ML2D/40-125C	425	100	325	397	200	197	340	130	210	20	100	50	G 1"1/2	40PN10	88	110	150	4	18
ML2D/40-125B	445	100	345	397	200	197	340	130	210	20	100	52	G 1"1/2	40PN10	88	110	150	4	18
ML2D/40-125A	445	100	345	397	200	197	340	130	210	20	100	54	G 1"1/2	40PN10	88	110	150	4	18

MODELLO POMPA PUMP'S MODEL	DIMENSIONI POMPA mm PUMP'S DIMENSIONS mm											PESO WEIGHT kg	DTA DTM	DNA DNM	FLANGE mm FLANGES mm				
	A	B	C	D	E	F	G	H	I	L	M				1	2	3	4	5
ML4D/50-125Y	435	110	325	427	217	210	365	145	220	22	105	44	G 2"	50PN10	102	125	156	4	18
ML4D/50-125X	435	110	325	427	217	210	365	145	220	22	105	46	G 2"	50PN10	102	125	156	4	18
ML4D/50-160X	435	110	325	480	245	235	410	170	240	22	105	52	G 2"	50PN10	102	125	156	4	18
ML2D/50-125C	455	110	345	427	217	210	365	145	220	22	105	56	G 2"	50PN10	102	125	156	4	18
ML2D/50-125B	455	110	345	427	217	210	365	145	220	22	105	58	G 2"	50PN10	102	125	156	4	18
ML2D/50-125A	495	110	385	427	217	210	365	145	220	22	105	66	G 2"	50PN10	102	125	156	4	18
ML2D/50-160B	535	110	425	480	245	235	410	170	240	22	105	67	G 2"	50PN10	102	125	156	4	18
ML2D/50-160A	495	110	385	480	245	235	410	170	240	22	105	86	G 2"	50PN10	102	125	156	4	18

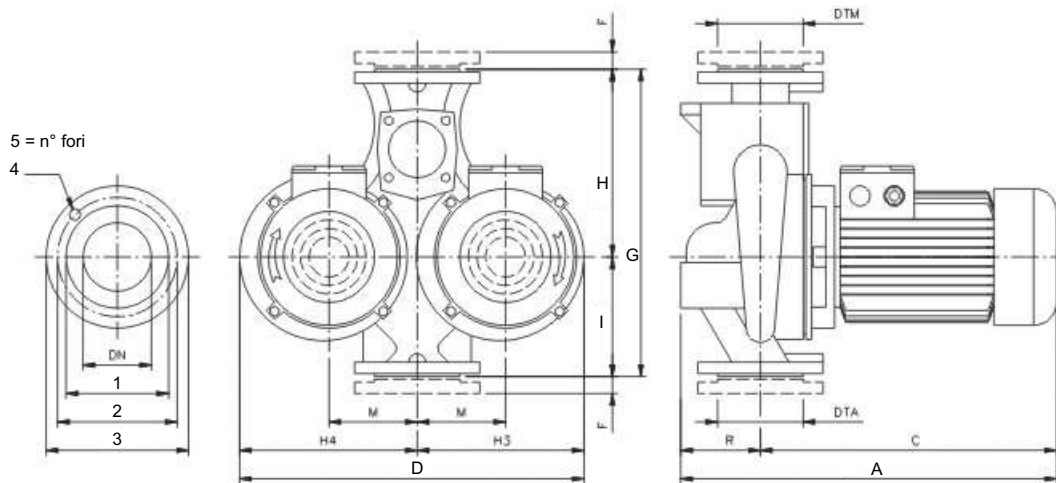

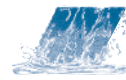

POMPE PER CIRCOLAZIONE DI ACQUA CALDA/FREDDA
PUMPS FOR HOT/COLD WATER CIRCULATION

MODELLO POMPA PUMP'S MODEL	DIMENSIONI POMPA mm PUMP'S DIMENSIONS mm											PESO WEIGHT kg	DTA DTM	DNA DNM	FLANGE mm FLANGES mm				
	A	B	C	D	E	F	G	H	I	L	M				1	2	3	4	5
ML4D/65-160Z	475	130	345	543	275	268	450	180	270	22	140	65	G 2" 1/2	65PN10	122	145	185	4	18
ML4D/65-160Y	475	130	345	543	275	268	450	180	270	22	140	65	G 2" 1/2	65PN10	122	145	185	4	18
ML4D/65-160X	475	130	345	543	275	268	450	180	270	22	140	67	G 2" 1/2	65PN10	122	145	185	4	18
ML2D/65-160D	485	130	345	543	275	268	450	180	270	22	140	81	G 2" 1/2	65PN10	122	145	185	4	18
ML2D/65-160C	565	130	435	543	275	268	450	180	270	22	140	101	G 2" 1/2	65PN10	122	145	185	4	18
ML2D/65-160B	565	130	435	543	275	268	450	180	270	22	140	110	G 2" 1/2	65PN10	122	145	185	4	18
ML2D/65-160A	670	130	540	543	275	268	450	180	270	22	140	125	G 2" 1/2	65PN10	122	145	185	4	18

MODELLO POMPA PUMP'S MODEL	DIMENSIONI POMPA mm PUMP'S DIMENSIONS mm											PESO WEIGHT kg	DTA DTM	DNA DNM	FLANGE mm FLANGES mm				
	A	B	C	D	E	F	G	H	I	L	M				1	2	3	4	5
ML4D/80-160W	485	150	335	550	280	270	510	205	305	24	135	72	G 3"	80PN10	138	160	200	4	18
ML4D/80-160Z	485	150	335	550	280	270	510	205	305	24	135	74	G 3"	80PN10	138	160	200	4	18
ML4D/80-160Y	535	150	385	550	280	270	510	205	305	24	135	79	G 3"	80PN10	138	160	200	4	18
ML4D/80-160X	535	150	385	550	280	270	510	205	305	24	135	83	G 3"	80PN10	138	160	200	4	18
ML2D/80-160D	690	150	540	550	280	270	510	205	305	24	135	110	G 3"	80PN10	138	160	200	4	18
ML2D/80-160C	690	150	540	550	280	270	510	205	305	24	135	148	G 3"	80PN10	138	160	200	4	18
ML2D/80-160B	690	150	540	550	280	270	510	205	305	24	135	162	G 3"	80PN10	138	160	200	4	18
ML2D/80-160A	690	150	540	550	280	270	510	205	305	24	135	175	G 3"	80PN10	138	160	200	4	18

MODELLO POMPA PUMP'S MODEL	DIMENSIONI POMPA mm PUMP'S DIMENSIONS mm											PESO WEIGHT kg	DTA DTM	DNA DNM	FLANGE mm FLANGES mm				
	A	B	C	D	E	F	G	H	I	L	M				1	2	3	4	5
ML4D/100-200W	535	180	355	670	325	345	630	240	390	26	165	110	G 4"	100PN10	158	180	220	8	18
ML4D/100-200Z	605	180	425	670	325	345	630	240	390	26	165	130	G 4"	100PN10	158	180	220	8	18
ML4D/100-200Y	605	180	425	670	325	345	630	240	390	26	165	138	G 4"	100PN10	158	180	220	8	18
ML4D/100-200X	615	180	435	670	325	345	630	240	390	26	165	150	G 4"	100PN10	158	180	220	8	18
ML2D/100-200D	720	180	540	670	325	345	630	240	390	26	165	200	G 4"	100PN10	158	180	220	8	18
ML2D/100-200C	720	180	540	670	325	345	630	240	390	26	165	162	G 4"	100PN10	158	180	220	8	18
ML2D/100-200B	720	180	540	670	325	345	630	240	390	26	165	162	G 4"	100PN10	158	180	220	8	18
ML2D/100-200A	720	180	540	670	325	345	630	240	390	26	165	162	G 4"	100PN10	158	180	220	8	18
ML2D/100-200F	720	180	540	670	325	345	630	240	390	26	165	230	G 4"	100PN10	158	180	220	8	18
ML2D/100-200E	720	180	540	670	325	345	630	240	390	26	165	214	G 4"	100PN10	158	180	220	8	18