

ELETTROPOMPE MULTIGIRANTI VERTICALI CON IDRAULICA INOX AISI 304  
 SS AISI 304 HYDRAULICS VERTICAL MULTISTAGE ELECTRIC PUMPS

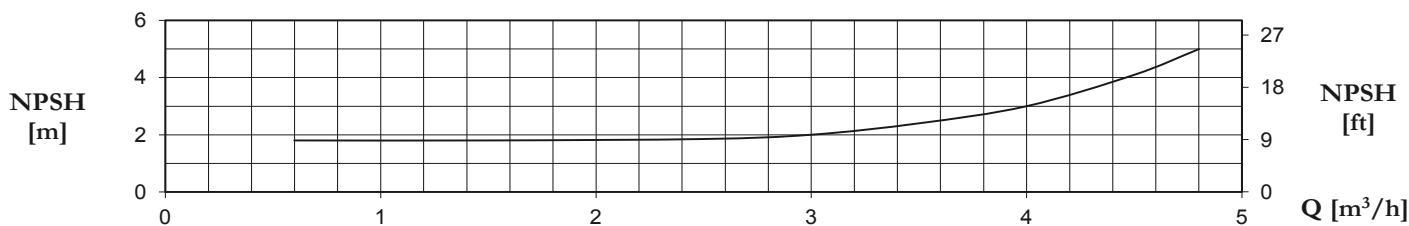

CARATTERISTICHE TECNICHE A 2900 GIRI / TECHNICAL PERFORMANCE AT 2900 RPM

Modello Model		P2		A		Q (m³/h -l/min)						
1~	3~	(HP)	(kW)	1x230V 50Hz	3x400V 50Hz	0	0,6	1,2	1,8	2,4	3,6	4,8
						0	10	20	30	40	60	80
H (m)												
U 3...-100/5	U 3...-100/5T	1	0,75	4,4	1,7	55,3	53,5	50,3	46,5	42,1	31,6	17,7
U 3...-120/6	U 3...-120/6T	1,2	0,9	5,1	2,5	66,6	64,4	60,8	56,0	50,7	38,1	22,4
U 3...-150/7	U 3...-150/7T	1,5	1,1	6,4	2,7	80,1	77,7	74,2	69,1	63,3	48,8	30,0
U 3...-180/8	U 3...-180/8T	1,8	1,3	6,9	2,7	91,5	88,8	84,8	79,0	72,3	55,8	34,3
U 3...-200/9	U 3...-200/9T	2	1,5	7,7	3,0	103,0	99,9	95,4	88,8	81,4	62,7	38,6
U 3...-250/10	U 3...-250/10T	2,5	1,8	9,2	3,7	114,4	111,0	106,0	98,7	90,4	69,7	42,9
U 3...-280/11	U 3...-280/11T	2,8	2,1	9,7	3,9	125,9	122,1	116,6	108,6	99,5	76,7	47,1
U 3...-300/12	U 3...-300/12T	3	2,2	10,3	4,3	137,3	133,2	127,2	118,5	108,5	83,7	51,4

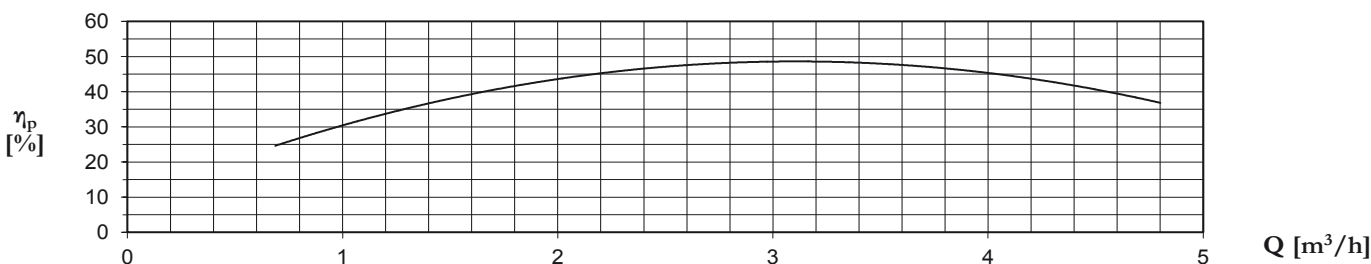
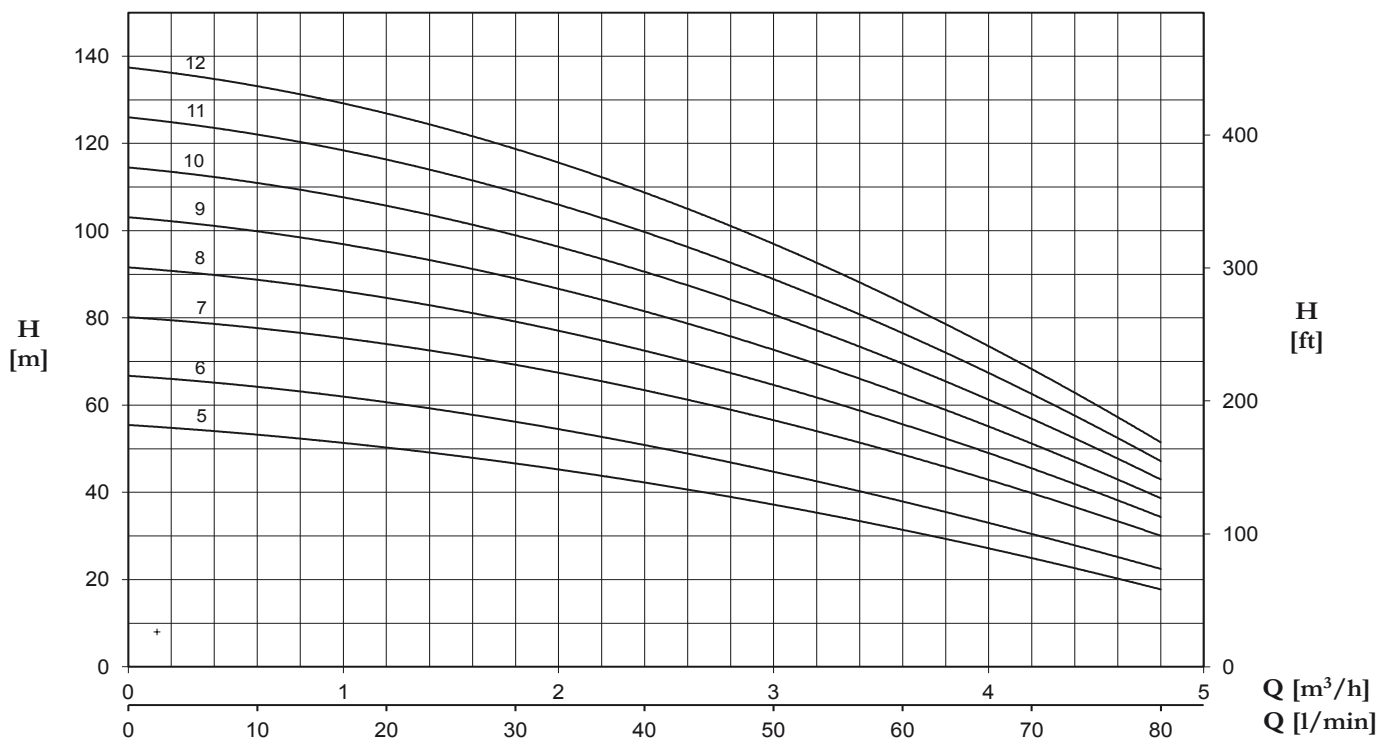
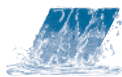

SERIE - SERIES

# ULTRA SV/SL/SLX

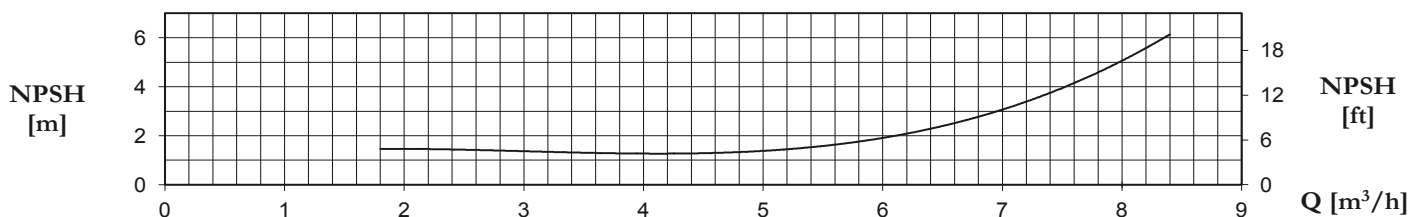
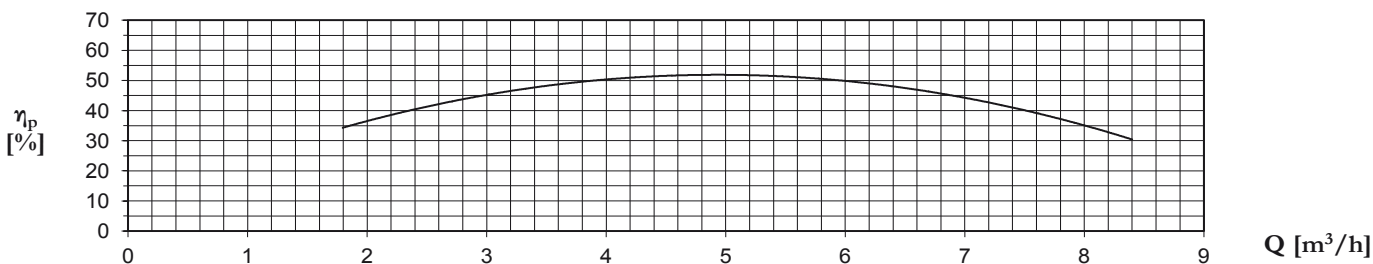
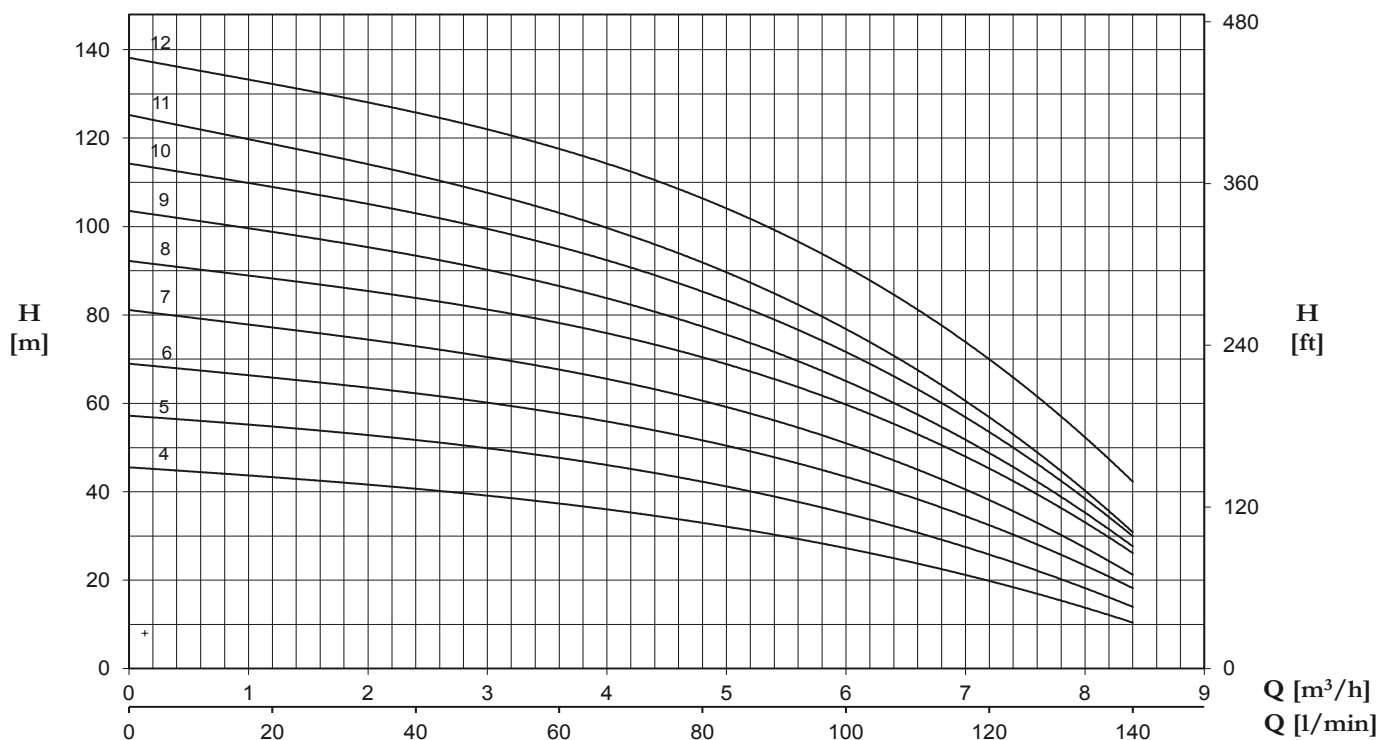

## CARATTERISTICHE TECNICHE A 2900 GIRI / TECHNICAL PERFORMANCE AT 2900 RPM

Modello Model		P2		A		Q (m³/h -l/min)							
1~	3~	(HP)	(kW)	1x230V 50Hz	3x400V 50Hz	0	1,8	2,4	3,6	4,8	6	7,2	8,4
						0	30	40	60	80	100	120	140
H (m)													
U 5...-120/4	U 5...-120/4T	1,2	0,9	4,9	2,4	45,5	42,2	40,7	37,2	32,9	27,4	19,8	10,4
U 5...-150/5	U 5...-150/5T	1,5	1,1	6,5	2,7	57,2	53,4	51,7	47,6	42,3	35,2	25,7	14,0
U 5...-180/6	U 5...-180/6T	1,8	1,3	7,3	3	68,9	64,4	62,3	57,5	51,5	43,5	32,6	18,1
U 5...-200/7	U 5...-200/7T	2	1,5	8,7	3,3	81	75,5	73	67,4	60,3	51,0	38,6	21,0
U 5...-250/8	U 5...-250/8T	2,5	1,9	10,1	4	92,1	86,5	84,0	77,8	70,1	60	45,5	26
U 5...-280/9	U 5...-280/9T	2,8	2,1	11	4,2	103,4	96,7	93,5	86	77,1	65,6	48,7	27,6
U 5...-300/10	U 5...-300/10T	3	2,2	11,9	4,7	114,2	106,4	102,9	95,2	85,2	72,0	53,3	30
U 5...-350/11	U 5...-350/11T	3,5	2,6	12,9	4,9	125,1	115,7	111,8	102,6	91,6	77,1	57,1	30,7
	U 5...-380/12T	3,8	2,8		6,0	138,1	129,4	125,9	117,4	106	91,2	70,1	42,2

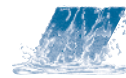

ELETTROPOMPE MULTIGIRANTI VERTICALI CON IDRAULICA INOX AISI 304  
 SS AISI 304 HYDRAULICS VERTICAL MULTISTAGE ELECTRIC PUMPS

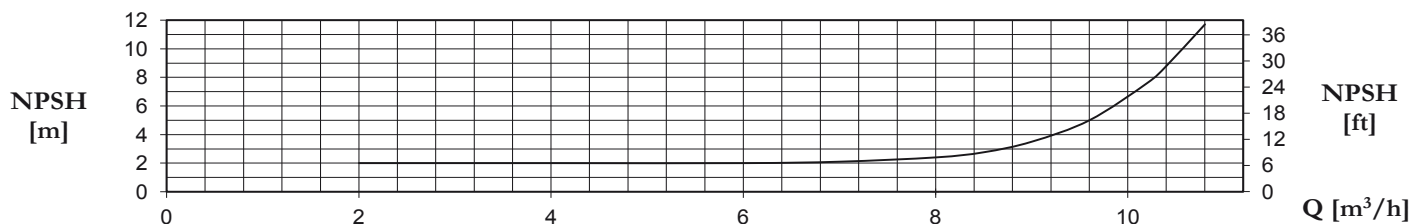
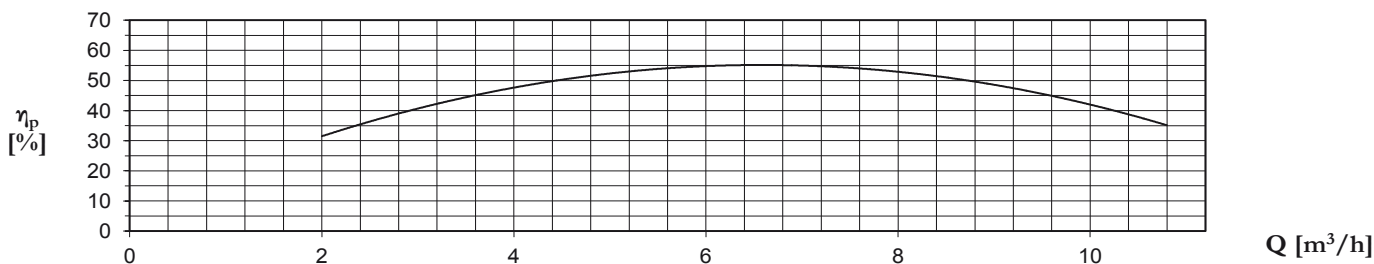
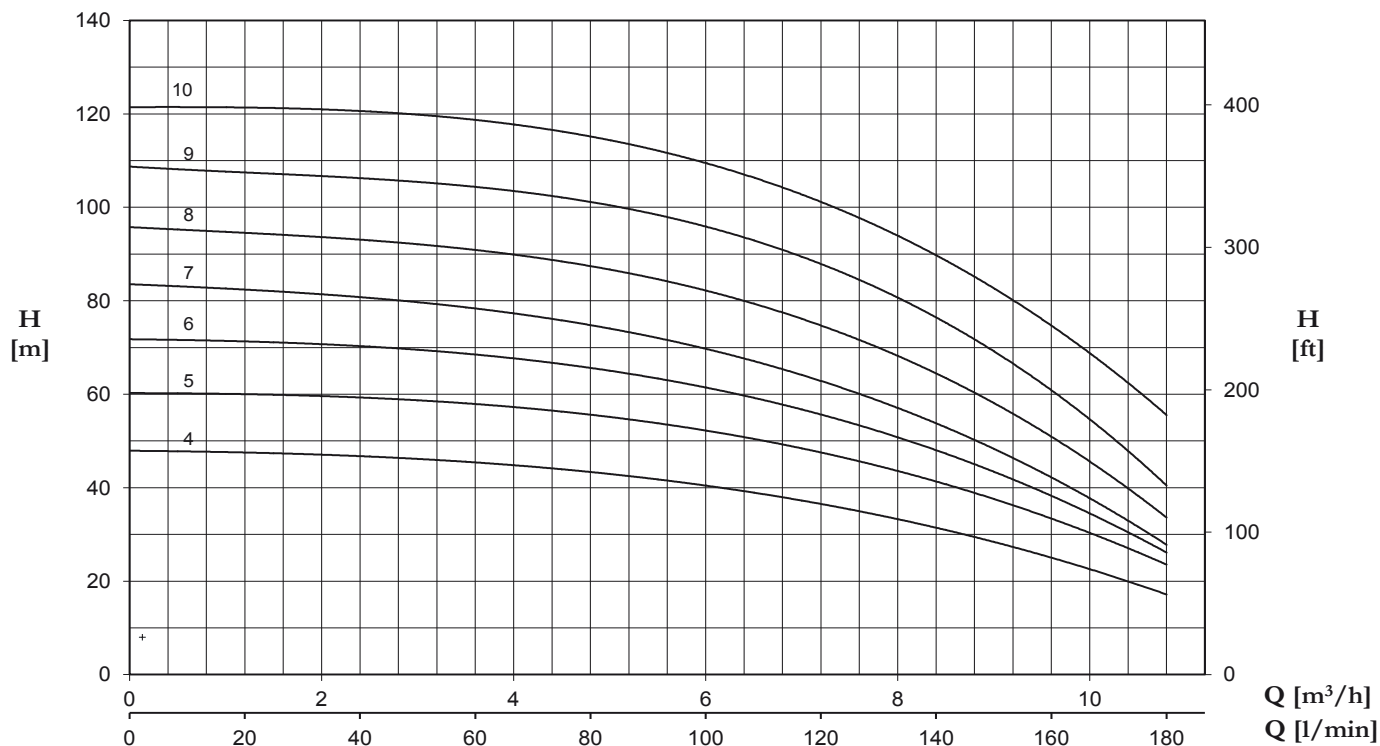

CARATTERISTICHE TECNICHE A 2900 GIRI / TECHNICAL PERFORMANCE AT 2900 RPM

Modello Model		P2		A		Q (m³/h -l/min)									
1~	3~	(HP)	(kW)	1x230V 50Hz	3x400V 50Hz	0	2,4	3,6	4,8	6	7,2	8,4	9,6	10,8	
						0	40	60	80	100	120	140	160	180	
H (m)															
U 7...-180/4	U 7...-180/4T	1,8	1,3	7,7	3,1	48,0	46,3	45,7	43,6	40,4	36,4	31,4	25,0	17,2	
U 7...-250/5	U 7...-250/5T	2,5	1,9	10,2	4,1	60,3	59,0	58,2	55,7	52,2	47,4	41,3	33,5	23,5	
U 7...-300/6	U 7...-300/6T	3	2,2	11,4	4,8	71,8	70,0	68,9	65,7	61,3	55,4	48,1	38,5	26,0	
	U 7...-350/7T	3,5	2,6		5,1	83,5	80,7	78,8	74,7	69,4	62,6	53,9	42,7	27,5	
	U 7...-400/8T	4	3		6	95,6	93,3	91,4	87,2	81,6	74,2	64,8	51,9	33,0	
	U 7...-450/9T	4,5	3,4		6,5	108,5	106,5	105,1	101,0	95,0	87,2	76,6	62,6	39,5	
	U 7...-550/10T	5,5	4		7,9	121,5	120,1	119,3	115,3	109,2	100,8	89,8	75,0	55,4	

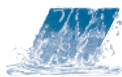

# ULTRA SV/S L/S LX

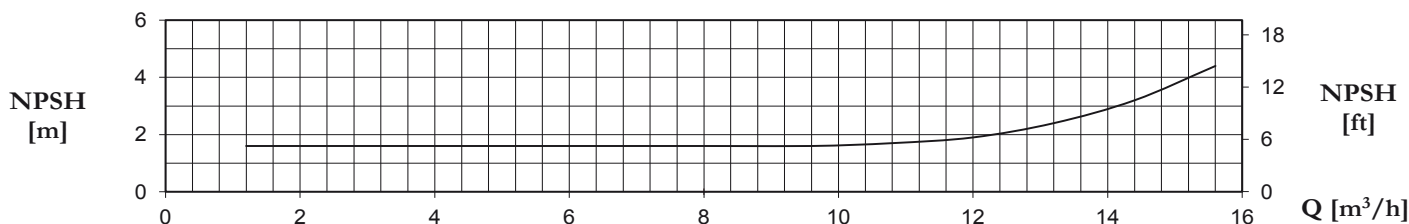
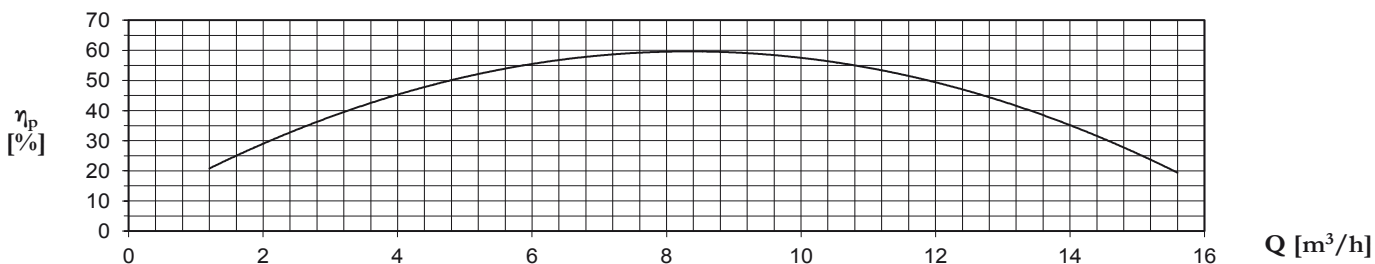
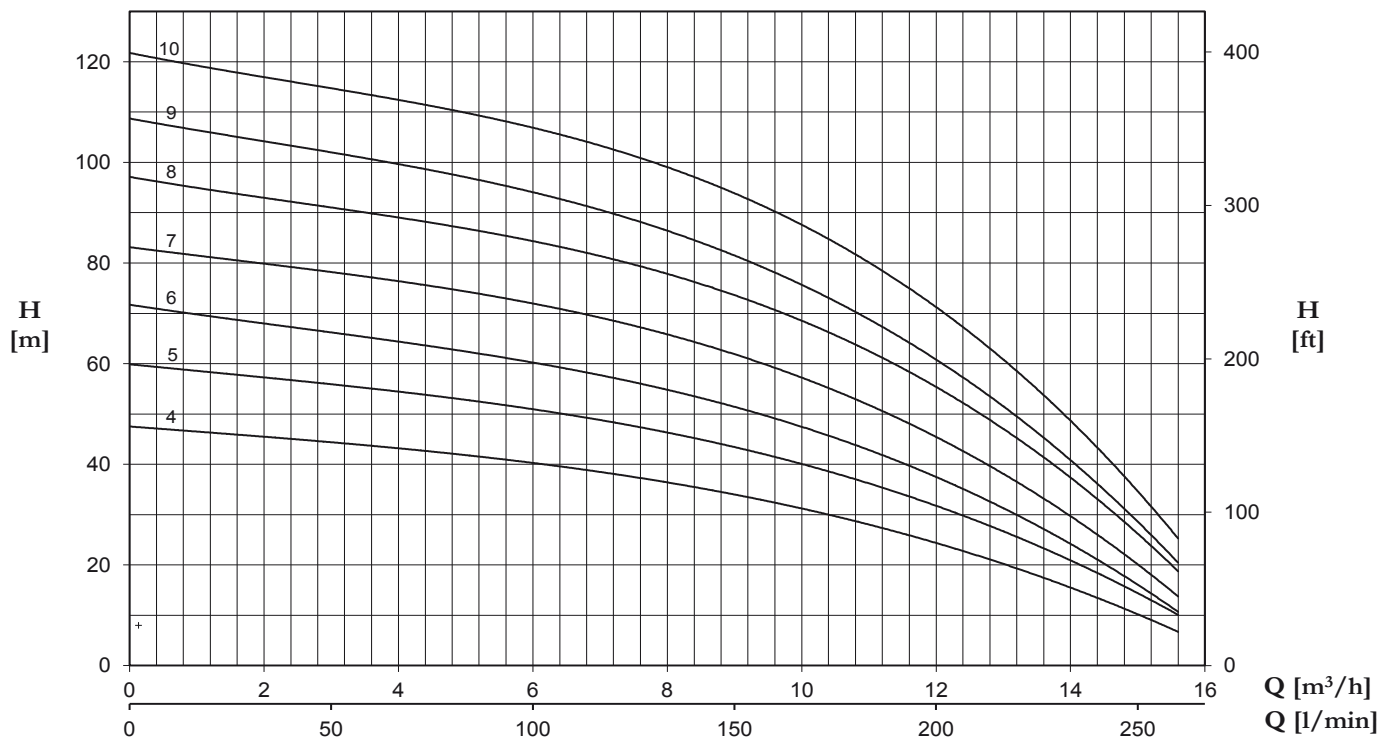

**CARATTERISTICHE TECNICHE A 2900 GIRI / TECHNICAL PERFORMANCE AT 2900 RPM**

Modello <i>Model</i>		P2		A		Q (m³/h -l/min)											
1~	3~	(HP)	(kW)	1x230V 50Hz	3x400V 50Hz	0	3,6	4,8	6	7,2	8,4	9,6	10,8	12	13,2	14,4	15,6
						0	60	80	100	120	140	160	180	200	220	240	260
H (m)																	
U 9...-200/4	U 9...-200/4T	2	1,5	8,4	3,3	47,6	43,5	42,1	40,1	38,1	35,7	32,7	28,9	24,3	19	13,1	7,1
U 9...-250/5	U 9...-250/5T	2,5	1,85	10,8	4,3	60	54,8	53	51	48,2	45,4	42	37,3	31,6	25	18	10,6
U 9...-300/6	U 9...-300/6T	3	2,2	12,5	4,9	71,8	64,9	63	59,9	57	53,7	49,7	44,3	37	29,5	20,8	11,1
	U 9...-400/7T	4	3		5,8	83,3	76,7	74,9	71,8	68,3	64,6	59,9	53,5	44,8	35,9	25,7	14,3
	U 9...-450/8T	4,5	3,31		6,4	97,3	89,5	87,3	84	80,5	75,6	71,6	64,8	54,9	44	32,4	19,7
	U 9...-500/9T	5	3,7		7	109	100	97,6	93,6	89,5	85	79,4	71,6	60,1	48	34,9	21,9
	U 9...-550/10T	5,5	4		8,3	122	112,8	110,5	106,5	102,2	97,3	91,6	82,8	70,7	57,1	42,3	26,5

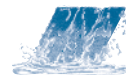

ELETTROPOMPE MULTIGIRANTI VERTICALI CON IDRAULICA INOX AISI 304  
 SS AISI 304 HYDRAULICS VERTICAL MULTISTAGE ELECTRIC PUMPS

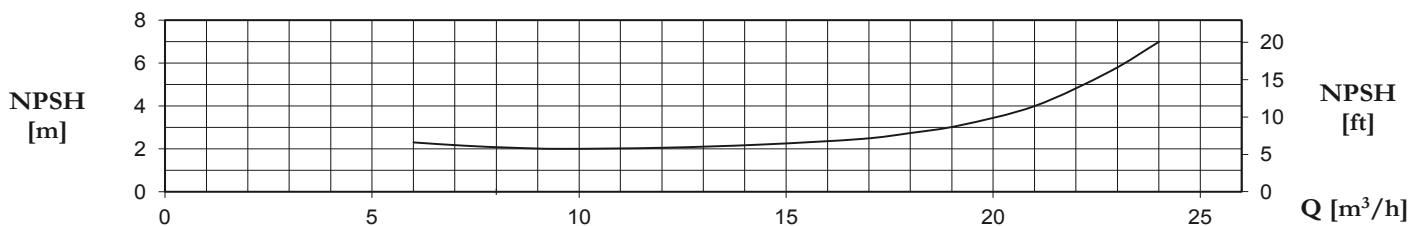
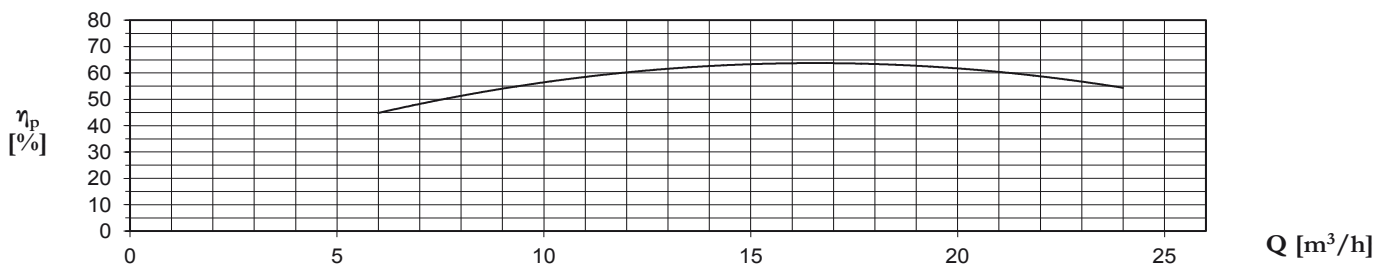
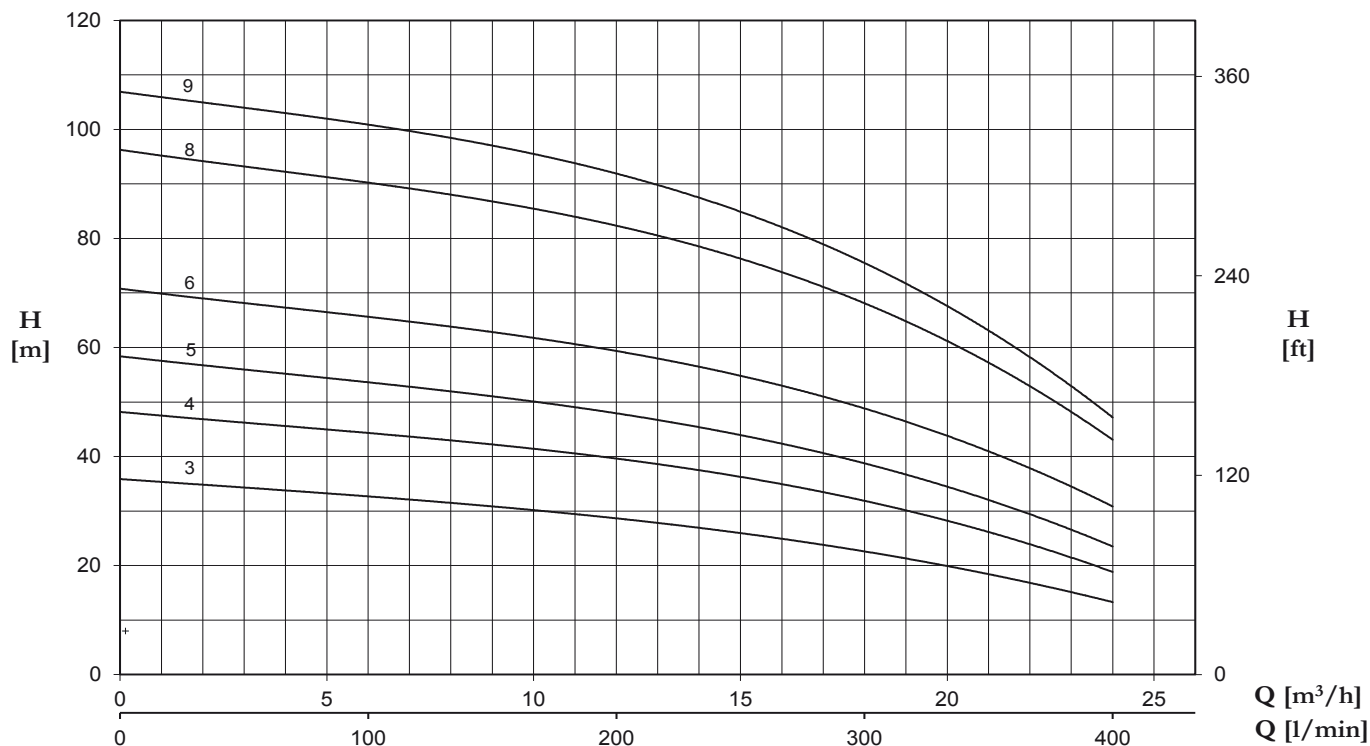

CARATTERISTICHE TECNICHE A 2900 GIRI / TECHNICAL PERFORMANCE AT 2900 RPM

Modello Model	P2		A	Q (m³/h -l/min)																
	(HP)	(kW)		0	6	7,2	8,4	9,6	10,8	12	13,2	14,4	15,6	16,8	18	19,2	20,4	21,6	22,8	24
3~			3x400V 50Hz	0	100	120	140	160	180	200	220	240	260	280	300	320	340	360	380	400
				H (m)																
U 18...-250/3T	2,5	1,85	4,4	35,7	33,1	32,3	31,3	30,4	29,4	28,4	27,4	26,3	25,1	24	22,8	21,4	19,6	17,8	15,4	12,9
U 18...-400/4T	4	3	5,7	47,9	45	44	42,8	41,7	40,5	39,1	37,8	36,6	35,2	33,9	32,2	30,2	28,0	25,1	22,1	18,1
U 18...-450/5T	4,5	3,31	6,7	58,1	54,3	53,1	51,8	50,4	49,0	47,4	45,9	44,3	42,7	41,0	39,2	37,0	34,0	30,8	26,9	23,0
U 18...-550/6T	5,5	4	8,7	70,5	66,4	65,0	63,6	62,0	60,5	58,9	57,2	55,4	53,5	51,5	49,3	46,3	43,3	39,4	34,9	30,4
U 18...-750/8T	7,5	5,5	10,9	95,9	90,9	89,58	88,0	86,1	83,9	81,6	79,5	76,8	74,4	71,8	68,5	65,0	60,4	55,2	49,0	42,2
U 18...-900/9T	9	6,6	12,7	106,4	101,8	100,4	98,6	96,1	93,5	91,0	88,2	85,5	82,7	79,7	76,2	72,1	66,9	60,8	53,7	46,1

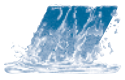

# ULTRA 5V/5L/5LX

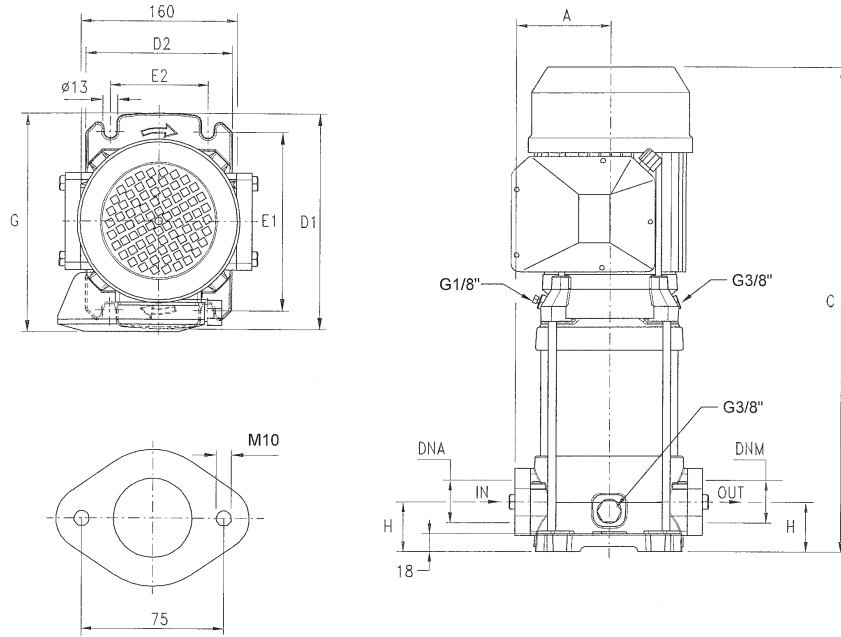

MODELLO POMPA PUMP'S MODEL	DIMENSIONI POMPA mm PUMP'S DIMENSIONS mm								PESO WEIGHT kg	DNA G	DNM G
	A	C	D1	D2	E1	E2	G	H			
U 3SL-100/5	98	429	220	150	180	100	228	50	20,2	1" 1/4	1" 1/4
U 3SL-120/6	98	453	220	150	180	100	228	50	21		
U 3SL-150/7	98	507	220	150	180	100	228	50	24,5		
U 3SL-180/8	98	531	220	150	180	100	228	50	25,7		
U 3SL-200/9	98	555	220	150	180	100	228	50	28		
U 3SL-250/10	98	579	220	150	180	100	228	50	28,9		
U 3SL-280/11	98	M 648 T 603	220	150	180	100	M 236 T 228	50	30,4		
U 3SL-300/12	98	M 672 T 627	220	150	180	100	M 236 T 228	50	31,7		

MODELLO POMPA PUMP'S MODEL	DIMENSIONI POMPA mm PUMP'S DIMENSIONS mm								PESO WEIGHT kg	DNA G	DNM G
	A	C	D1	D2	E1	E2	G	H			
U 5SL-150/5	98	459	220	150	180	100	228	50	23,7	1" 1/4	1" 1/4
U 5SL-180/6	98	483	220	150	180	100	228	50	24,9		
U 5SL-200/7	98	507	220	150	180	100	228	50	27		
U 5SL-250/8	98	531	220	150	180	100	228	50	28		
U 5SL-280/9	98	M 600 T 555	220	150	180	100	M 236 T 228	50	30,8		
U 5SL-300/10	98	M 624 T 579	220	150	180	100	M 236 T 228	50	31,4		
U 5SL-350/11	98	648	220	150	180	100	228	50	34,7		
U 7SL-180/4	98	435	220	150	180	100	228	50	23,8	1" 1/4	1" 1/4

MODELLO POMPA PUMP'S MODEL	DIMENSIONI POMPA mm PUMP'S DIMENSIONS mm								PESO WEIGHT kg	DNA G	DNM G
	A	C	D1	D2	E1	E2	G	H			
U 7SL-250/5	98	459	220	150	180	100	228	50	26,1	1" 1/4	1" 1/4
U 7SL-300/6	98	M 528 T 483	220	150	180	100	M 236 T 228	50	29		
U 7SL-350/7	98	552	220	150	180	100	228	50	29,8		
U 7SL-400/8	98	576	220	150	180	100	228	50	33,3		
U 7SL-450/9	98	633	220	150	180	100	251	50	37,7		
U 7SL-550/10	98	657	220	150	180	100	251	50	41		

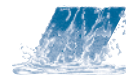

**ELETTROPOMPE MULTIGIRANTI VERTICALI CON IDRAULICA INOX AISI 304**  
**SS AISI 304 HYDRAULICS VERTICAL MULTISTAGE ELECTRIC PUMPS**

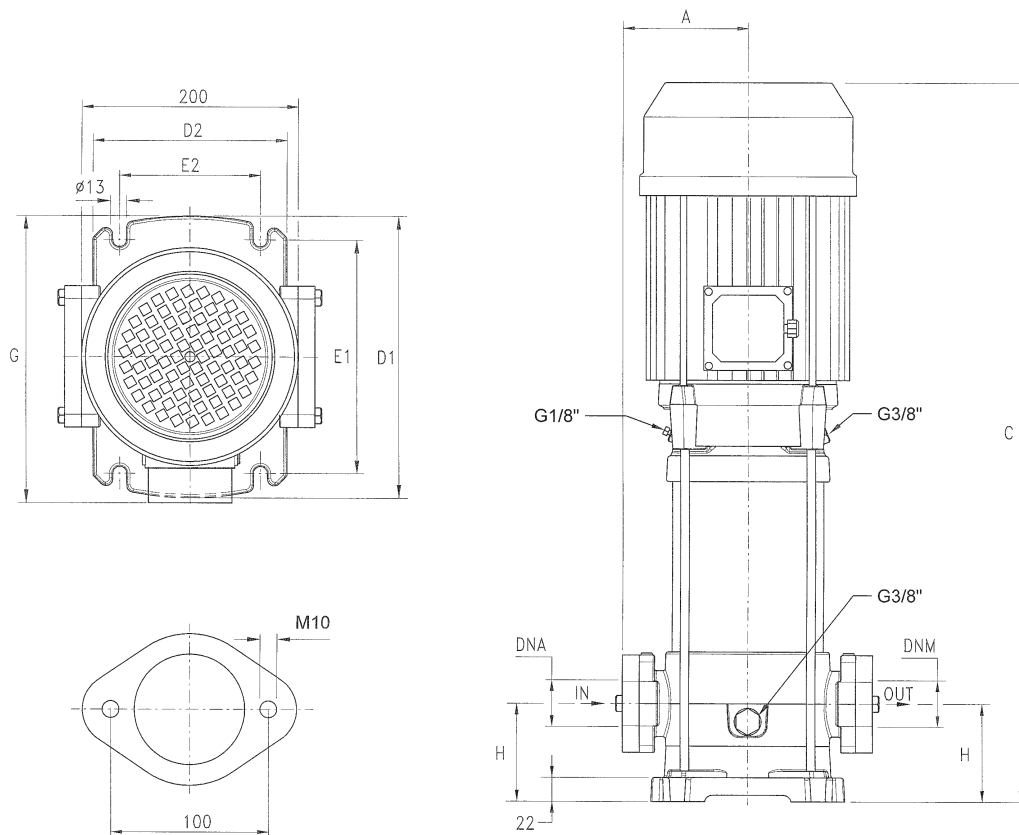

MODELLO POMPA PUMP'S MODEL	DIMENSIONI POMPA mm PUMP'S DIMENSIONS mm								PESO WEIGHT kg	DNA G	DNM G
	A	C	D1	D2	E1	E2	G	H			
U 9SL-200/4	118	490	260	180	215	130	248	80	29,9	1" 1/2	1" 1/2
U 9SL-250/5	118	520	260	180	215	130	248	80	30,9		
U 9SL-300/6	118	M 595 T 550	260	180	215	130	M 256 T 248	80	33,8		
U 9SL-400/7	118	625	260	180	215	130	256	80	37,6		
U 9SL-450/8	118	688	260	180	215	130	271	80	41,3		
U 9SL-500/9	118	718	260	180	215	130	271	80	42,1		
U 9SL-550/10	118	748	260	180	215	130	271	80	45,5		

MODELLO POMPA PUMP'S MODEL	DIMENSIONI POMPA mm PUMP'S DIMENSIONS mm								PESO WEIGHT kg	DNA G	DNM G
	A	C	D1	D2	E1	E2	G	H			
U 18SL-250/3	118	492	260	180	215	130	248	90	33,5	2"	2"
U 18SL-400/4	118	575	260	180	215	130	256	90	36,1		
U 18SL-450/5	118	646	260	180	215	130	271	90	40,4		
U 18SL-550/6	118	683	260	180	215	130	271	90	44,4		
U 18SL-750/8	118	804	260	180	215	130	280	90	54,3		
U 18SL-900/9	118	842	260	180	215	130	280	90	54,6		



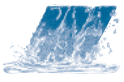

# ULTRA SV/SL/SLX

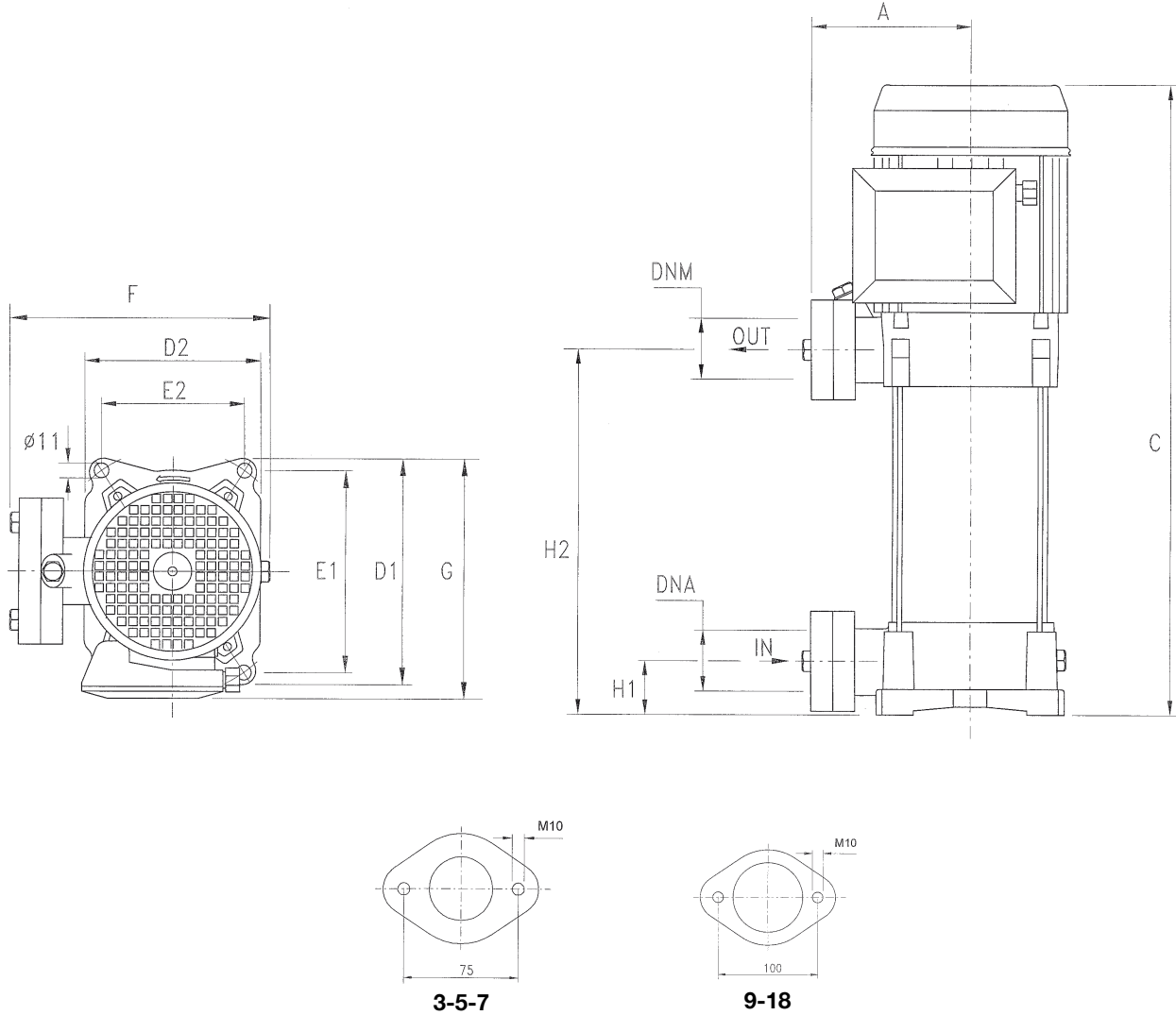

MODELLO POMPA PUMP'S MODEL	DIMENSIONI POMPA mm PUMP'S DIMENSIONS mm										PESO WEIGHT kg	DNA G	DNM G
	A	C	D1	D2	E1	E2	F	G	H1	H2			
U 3SV-100/5	135	413	204	162	178,5	125	229	213	40	178	19	1" 1/4	1" 1/4
U 3SV-120/6	135	437	204	162	178,5	125	229	213	40	202	19,7		
U 3SV-150/7	135	491	204	162	178,5	125	229	220	40	226	22,8		
U 3SV-180/8	135	515	204	162	178,5	125	229	220	40	250	24		
U 3SV-200/9	135	539	204	162	178,5	125	229	220	40	274	25,4		
U 3SV-250/10	135	563	204	162	178,5	125	229	220	40	298	26,2		
U 3SV-280/11	135	M 632 T 587	204	162	178,5	125	229	M 228 T 220	40	322	27,7		
U 3SV-300/12	135	M 656 T 611	204	162	178,5	125	229	M 228 T 220	40	346	29,3		

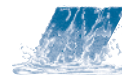

ELETTROPOMPE MULTIGIRANTI VERTICALI CON IDRAULICA INOX AISI 304  
 SS AISI 304 HYDRAULICS VERTICAL MULTISTAGE ELECTRIC PUMPS

MODELLO POMPA PUMP'S MODEL	DIMENSIONI POMPA mm PUMP'S DIMENSIONS mm										PESO WEIGHT kg	DNA G	DNM G
	A	C	D1	D2	E1	E2	F	G	H1	H2			
U 5SV-120/4	135	389	204	162	178,5	125	229	213	40	178	19,5	1" 1/4	1" 1/2
U 5SV-150/5	135	443	204	162	178,5	125	229	215	40	208,5	22,1		
U 5SV-180/6	135	467	204	162	178,5	125	229	215	40	232,5	2,3		
U 5SV-200/7	135	491	204	162	178,5	125	229	215	40	256,5	25,4		
U 5SV-250/8	135	515	204	162	178,5	125	229	215	40	280,5	26,2		
U 5SV-280/9	135	M 584 T 539	204	162	178,5	125	229	M 230 T 215	40	304,5	28,8		
U 5SV-300/10	135	M 608 T 563	204	162	178,5	125	229	M 230 T 215	40	328,5	29,5		
U 5SV-350/11	135	626	204	162	178,5	125	229	230	40	352,5	32,8		

MODELLO POMPA PUMP'S MODEL	DIMENSIONI POMPA mm PUMP'S DIMENSIONS mm										PESO WEIGHT kg	DNA G	DNM G
	A	C	D1	D2	E1	E2	F	G	H1	H2			
U 7SV-180/4	135	419	204	162	178,5	125	229	215	40	184,5	22,1	1" 1/4	1" 1/4
U 7SV-250/5	135	443	204	162	178,5	125	229	215	40	208,5	24,5		
U 7SV-300/6	135	467	204	162	178,5	125	229	215	40	232,5	27,3		
U 7SV-350/7	135	552	204	162	178,5	125	229	230	40	256,5	28,0		
U 7SV-400/8	135	576	204	162	178,5	125	229	230	40	280,5	31,2		
U 7SV-450/9	135	633	204	162	178,5	125	235	250	40	304,5	36,0		
U 7SV-550/10	135	657	204	162	178,5	125	235	250	40	328,5	39,4		

MODELLO POMPA PUMP'S MODEL	DIMENSIONI POMPA mm PUMP'S DIMENSIONS mm										PESO WEIGHT kg	DNA G	DNM G
	A	C	D1	D2	E1	E2	F	G	H1	H2			
U 9SV-200/4	135	443	204	162	178,5	125	229	215	40	208,5	23,9	1" 1/2	1" 1/4
U 9SV-250/5	135	473	204	162	178,5	125	229	215	40	238,5	24,8		
U 9SV-300/6	135	M 548 T 503	204	162	178,5	125	229	M 230 T 215	40	268,5	27,9		
U 9SV-400/7	135	578	204	162	178,5	125	229	230	40	298,5	31,2		
U 9SV-450/8	135	641	204	162	178,5	125	235	250	40	328,5	35,9		
U 9SV-500/9	135	671	204	162	178,5	125	235	250	40	358,5	36,7		
U 9SV-550/10	135	701	204	162	178,5	125	235	250	40	388,5	40,0		

MODELLO POMPA PUMP'S MODEL	DIMENSIONI POMPA mm PUMP'S DIMENSIONS mm										PESO WEIGHT kg	DNA G	DNM G
	A	C	D1	D2	E1	E2	F	G	H1	H2			
U 18SV-250/3T	135	451	204	162	178,5	125	229	215	50	213,5	28,6	2"	1" 1/2
U 18SV-400/4T	135	534	204	162	178,5	125	229	230	50	251	31,1		
U 18SV-450/5T	135	605	204	162	178,5	125	235	250	50	288,5	36,2		
U 18SV-550/6T	135	642	204	162	178,5	125	235	250	50	326	40,0		
U 18SV-750/8T	135	763	204	162	178,5	125	255	253	50	401	50,4		
U 18SV-900/9T	135	801	204	162	178,5	125	255	253	50	439	51,0		