

ULTRA V/L

**V****L**

ULTRA V con bocche contrapposte, ULTRA L con bocche in linea.
ULTRA V with top and bottom bores, ULTRA L with in-line bores.

GENERALITÀ / FEATURES

Pompe centrifughe multistadio verticali con corpo pompa e parte idraulica in Noryl®. Movimentazione di liquidi non carichi nei settori civili, agricoli ed industriali; sistemi di pressurizzazione; irrigazione; acque potabili o con glicole in soluzione; trattamento acque; industria alimentare; riscaldamento e condizionamento; sistemi di lavaggio.

Stainless steel multistage vertical pumps. Pumping of clean non-loaded fluids in the domestic; agricultural and industrial sectors; pressurizing system; irrigation; drinking and glycol water; water treatment; food industry; heating and air conditioning; washing system.

MATERIALI / MATERIALS

- Supporto e corpo pompa: ghisa
- Camicia: acciaio cromo-nickel AISI 304
- Giranti: Noryl®
- Albero: acciaio cromo-nickel AISI 304
- Tenuta meccanica: ceramica-grafite fino a 6 stadi / grafite-carburo di silicio da 7 stadi
- Cuscinetto intermedio guida-albero: ceramica-carburo di tungsteno
- Guarnizioni corpo pompa: EPDM
- *Motor bracket and pump body: cast iron*
- *Shell: chromo-nickel steel AISI 304*
- *Impellers: Noryl®*
- *Pump shaft: AISI 304 chromo-nickel steel*
- *Mechanical seal: ceramic-graphite up to 6 stages - graphite-silicon carbide from 7 stages*
- *Intermediate shaft guiding stage bush: ceramic-tungsten carbide*
- *Pump body gasket: EPDM*

MOTORE / MOTOR

- Motore 2 poli ad induzione
- Monofase 230V-50Hz con protezione termica fino a 1,85 kW
- Trifase 230/400V-50Hz
- Isolamento classe F
- Protezione IP44; IP55 da 4,5 HP
- *2 pole induction motor*
- *Single-phase 230V-50Hz with motor protection up to 1,85 kW*
- *Three-phase 230/400V-50Hz*
- *Insulation class F*
- *Protection degree IP44; IP55 from 4,5 HP*

LIMITI DI IMPIEGO / OPERATING CONDITIONS

- Pressione massima di esercizio 8 bar fino a 6 giranti; 14 bar da 7 giranti
- Temperatura d'esercizio del liquido pompato: da 5° a 35°C
- *Maximum working pressure: 8 bar up to 6 impellers; 14 bar from 7 impellers*
- *Maximum liquid temperature: from 5° up to 35°C*

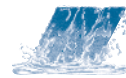

ELETTROPOMPE MULTIGIRANTI VERTICALI CON GIRANTE E DIFFUSORI NORYL®
 NORYL® IMPELLERS AND DIFFUSERS VERTICAL MULTISTAGE ELECTRIC PUMPS

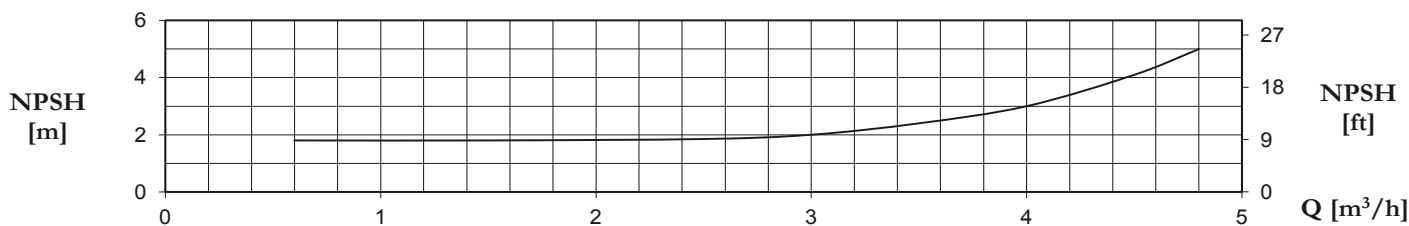
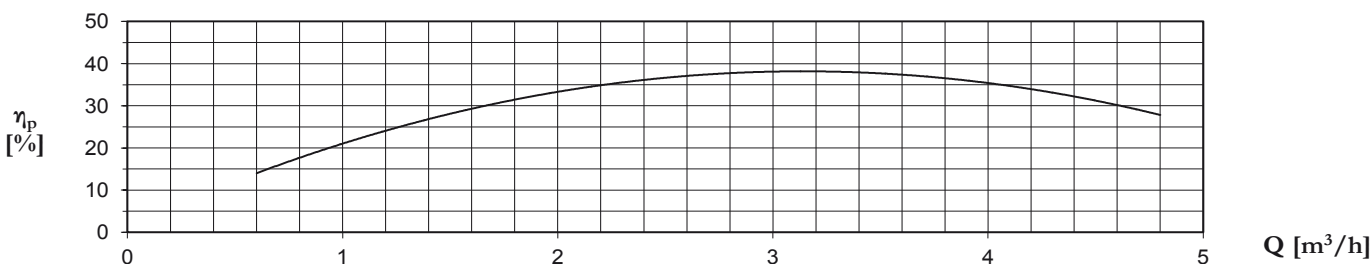
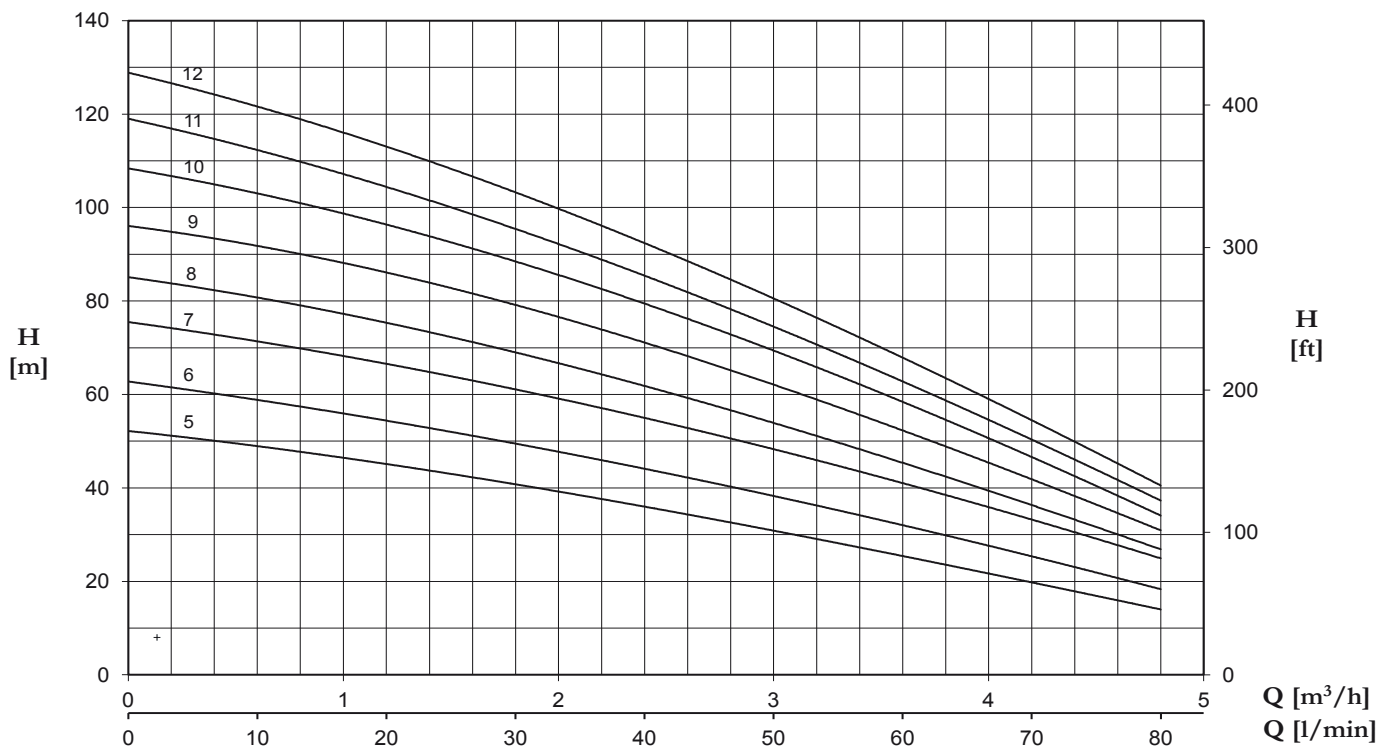

CARATTERISTICHE TECNICHE A 2900 GIRI / TECHNICAL PERFORMANCE AT 2900 RPM

Modello Model		P2		A		Q (m³/h -l/min)						
1~	3~	(HP)	(kW)	1x230V 50Hz	3x400V 50Hz	0	0,6	1,2	1,8	2,4	3,6	4,8
						0	10	20	30	40	60	80
H (m)												
U 3...-100/5	U 3...-100/5T	1	0,75	4,8	1,9	52,2	48,9	45,1	40,8	36,0	25,4	14,0
U 3...-120/6	U 3...-120/6T	1,2	0,9	5,6	2,6	62,8	58,7	54,5	49,6	43,9	32,1	18,3
U 3...-150/7	U 3...-150/7T	1,5	1,1	7,1	2,9	75,5	71,3	66,6	61,2	54,8	41,1	24,9
U 3...-180/8	U 3...-180/8T	1,8	1,3	7,5	3	85,2	80,6	75,1	69,3	61,9	45,2	26,9
U 3...-200/9	U 3...-200/9T	2	1,5	8,4	3,3	95,8	92,2	86,3	78,9	70,7	52,7	30,8
U 3...-250/10	U 3...-250/10T	2,5	1,8	10	4,1	108,4	102,9	96,5	88,2	79,7	58,3	34,1
U 3...-280/11	U 3...-280/11T	2,8	2,1	10,5	4,3	119,0	112,3	104,4	95,3	85,6	62,7	37,3
U 3...-300/12	U 3...-300/12T	3	2,2	11,2	4,7	128,9	121,5	113	103,5	92,2	67,9	40,5

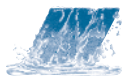

ULTRA V/L

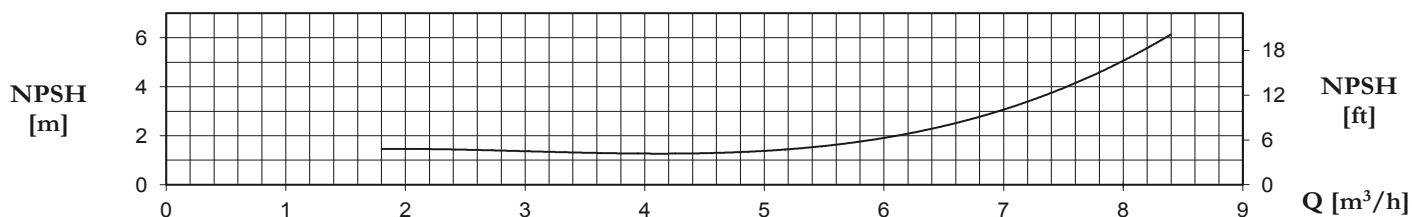
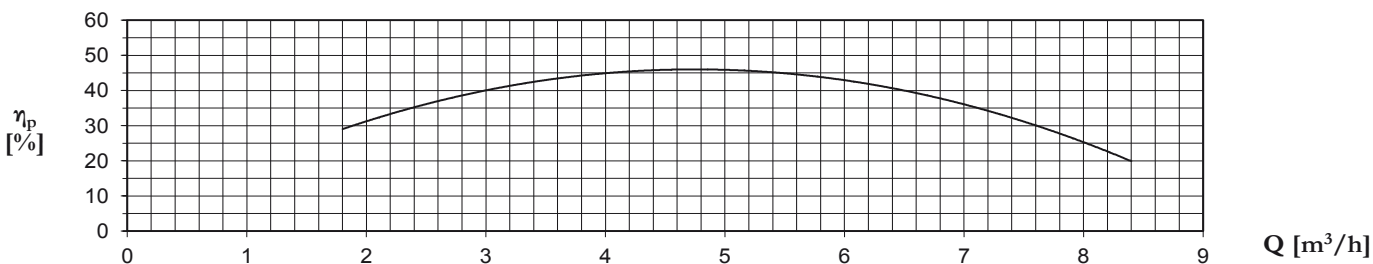
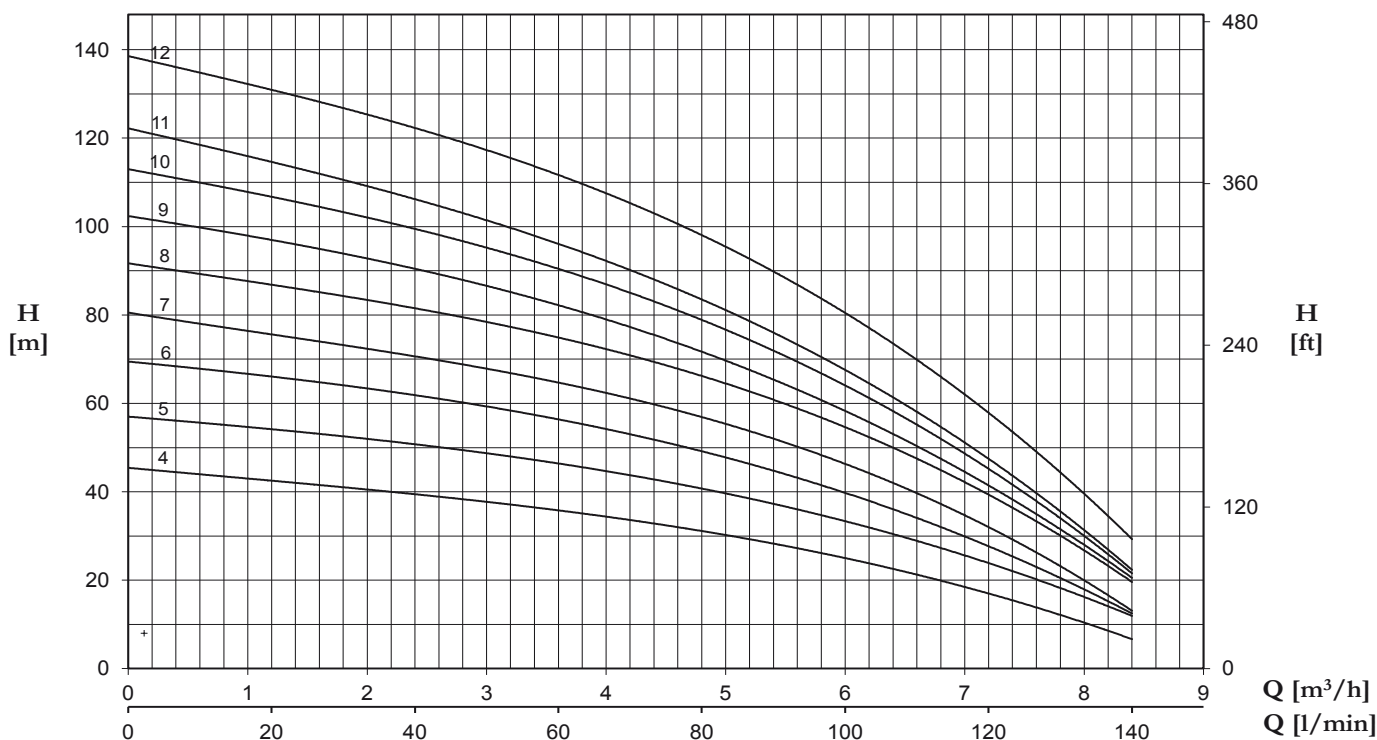

CARATTERISTICHE TECNICHE A 2900 GIRI / TECHNICAL PERFORMANCE AT 2900 RPM

Modello Model		P2		A		Q (m³/h -l/min)							
						0	1,8	2,4	3,6	4,8	6	7,2	8,4
						0	30	40	60	80	100	120	140
						H (m)							
1~	3~	(HP)	(kW)	1x230V 50Hz	3x400V 50Hz								
U 5...-120/4	U 5...-120/4T	1,2	0,9	5,2	2,5	45,3	41,3	39,6	35,6	30,8	24,9	17,6	6,4
U 5...-150/5	U 5...-150/5T	1,5	1,1	6,8	2,8	56,8	53	51	46,1	40,1	33,3	24,8	11,5
U 5...-180/6	U 5...-180/6T	1,8	1,3	7,7	3	69,3	64,4	62	55,6	48,2	39,6	28,8	12
U 5...-200/7	U 5...-200/7T	2	1,5	9	3,4	80,3	73,6	71	64,5	56,1	46	33,4	12,5
U 5...-250/8	U 5...-250/8T	2,5	1,85	10,7	4,1	91,4	85	81,8	74,3	65,5	54,7	40,4	19,1
U 5...-280/9	U 5...-280/9T	2,8	2,1	11,7	4,4	102,1	94,6	90,7	81,6	71	58,5	42,3	20,1
U 5...-300/10	U 5...-300/10T	3	2,2	12,8	4,9	112,7	103,9	99,9	89,8	78,25	64	46,4	21
U 5...-350/11	U 5...-350/11T	3,5	2,57	13,3	5	122	111,2	106,3	95,6	83,1	67,6	48,2	22
	U 5...-380/12T	3,8	2,85		6,0	138,4	127,2	122,4	111,7	97,3	80,4	58,8	28,9

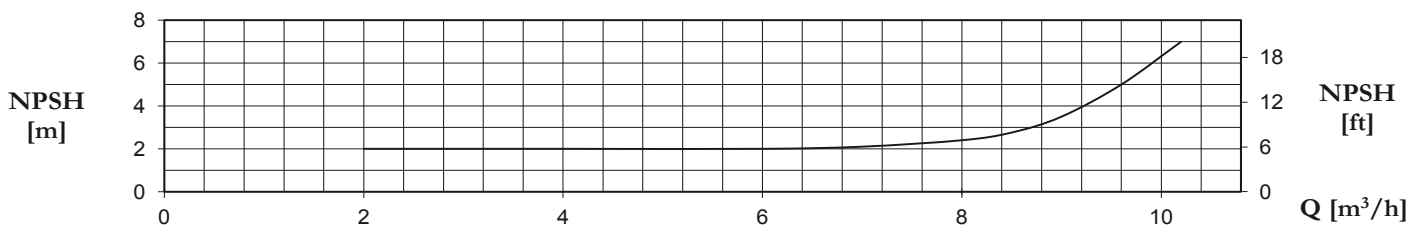
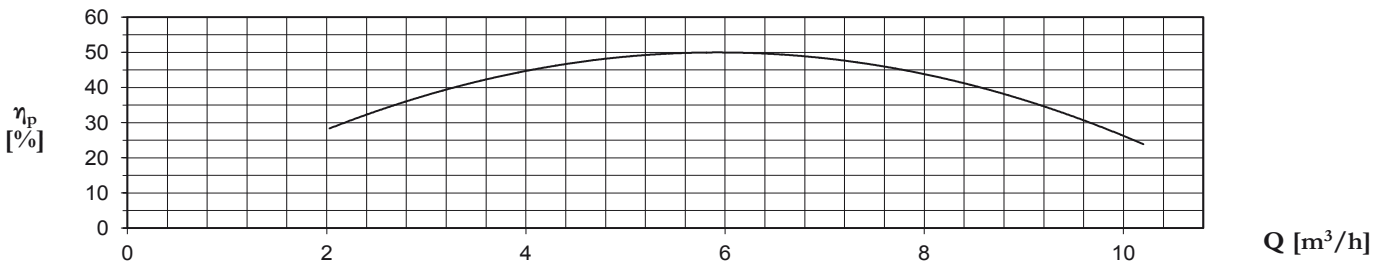
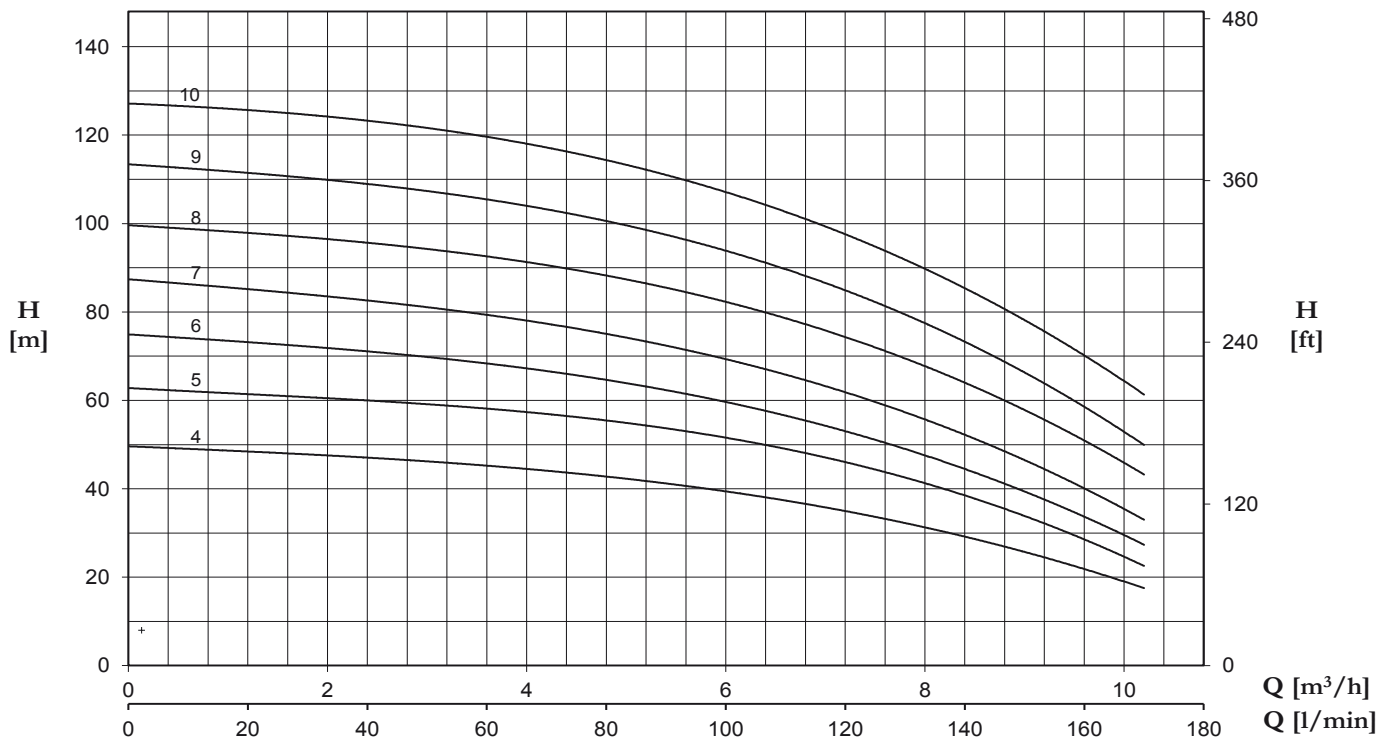
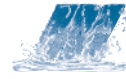

CARATTERISTICHE TECNICHE A 2900 GIRI / TECHNICAL PERFORMANCE AT 2900 RPM

Modello Model		P2		A		Q (m³/h - l/min)									
1~	3~	(HP)	(kW)	1x230V 50Hz	3x400V 50Hz	0	2,4	3,6	4,8	6	7,2	8,4	9,6	10,2	
						0	40	60	80	100	120	140	160	170	
H (m)															
U 7...-180/4	U 7...-180/4T	1,8	1,3	8,3	3,2	49,5	47,4	45,3	42,5	39,2	34,8	29,4	22,6	16,9	
U 7...-250/5	U 7...-250/5T	2,5	1,85	10,9	4,2	62,6	60,6	58,2	55,1	51,5	45,8	39	29,8	21,5	
U 7...-300/6	U 7...-300/6T	3	2,2	12,2	5	74,8	71,5	68,3	64,5	59,3	53	44,6	34,5	26,7	
	U 7...-350/7T	3,5	2,57		5,5	87,2	83,3	79,3	74,6	68,9	61,9	52,5	41	32,2	
	U 7...-400/8T	4	3		6,8	99,5	96,1	92,6	87,9	81,9	74,6	64,4	51	43	
	U 7...-450/9T	4,5	3,31		7	113,2	109,7	105,4	100,1	93,5	84,8	73,6	59,6	49	
	U 7...-550/10T	5,5	4		8,3	127	123,8	119,6	114,1	106,6	97,6	86	70,3	61	

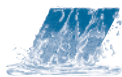

ULTRA V/L

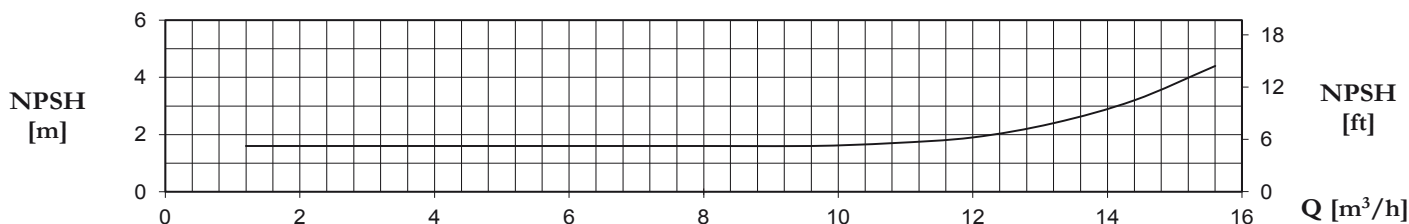
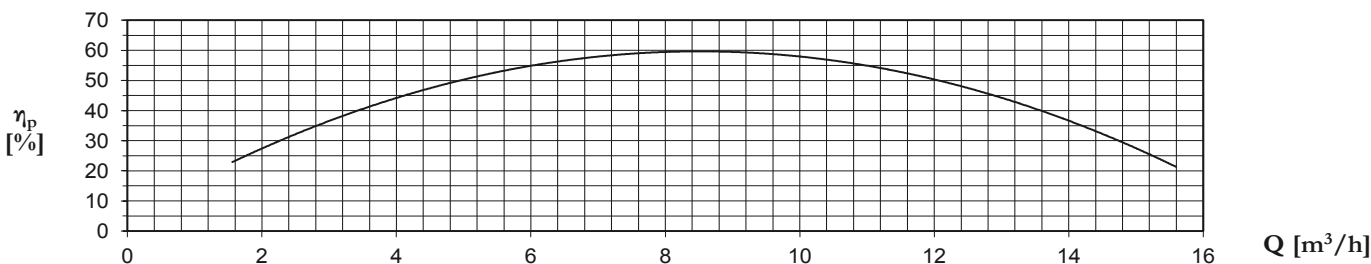
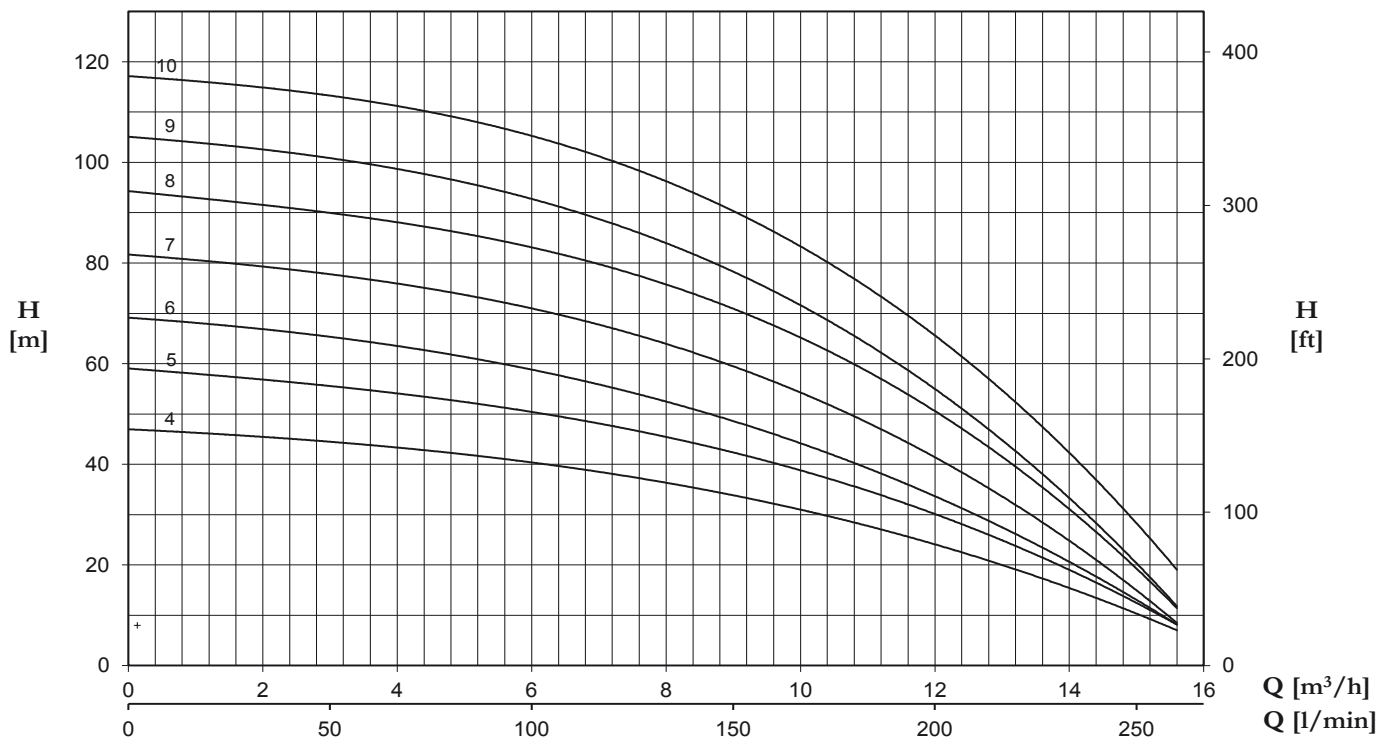

CARATTERISTICHE TECNICHE A 2900 GIRI / TECHNICAL PERFORMANCE AT 2900 RPM

Modello <i>Model</i>		P2		A		Q (m³/h -l/min)											
1~	3~	(HP)	(kW)	1x230V 50Hz	3x400V 50Hz	0	3,6	4,8	6	7,2	8,4	9,6	10,8	12	13,2	14,4	15,6
						0	60	80	100	120	140	160	180	200	220	240	260
H (m)																	
U 9...-200/4	U 9...-200/4T	2	1,5	8,4	3,3	47,1	43,5	42	40,5	38,3	35,7	32,4	28,4	23,8	18,9	13,3	7,3
U 9...-250/5	U 9...-250/5T	2,5	1,85	10,6	4,3	59,2	54,4	52,4	50,4	47,9	44,8	40,5	35,5	29,8	23,5	16,3	8,5
U 9...-300/6	U 9...-300/6T	3	2,2	12,2	4,8	69,4	63,7	61,4	58,8	55,6	51,6	46,5	40,3	33,5	25,4	17	9
	U 9...-400/7T	4	3		5,7	82	76	73,7	70,9	67,5	63	57	49,7	41	31,2	20,1	9,5
	U 9...-450/8T	4,5	3,31		6,4	94,5	88,4	86	83	79,4	74,7	68	59,8	49,8	38,9	27	11,6
	U 9...-500/9T	5	3,7		6,9	105,4	98,9	96,1	92,7	88,5	82,8	75	65,4	54,5	41,8	28	12,5
	U 9...-550/10T	5,5	4		8,3	117,6	111	108,4	105,3	101,1	95,1	87,2	76,7	64,8	51,2	36,4	20,1

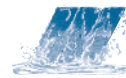

ELETTROPOMPE MULTIGIRANTI VERTICALI CON GIRANTE E DIFFUSORI NORYL®
 NORYL® IMPELLERS AND DIFFUSERS VERTICAL MULTISTAGE ELECTRIC PUMPS

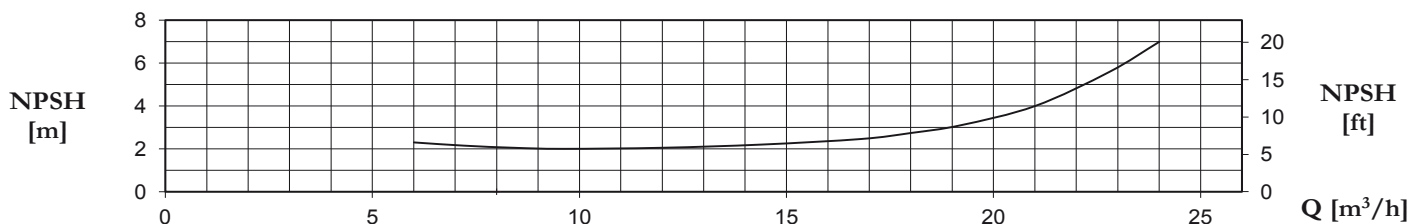
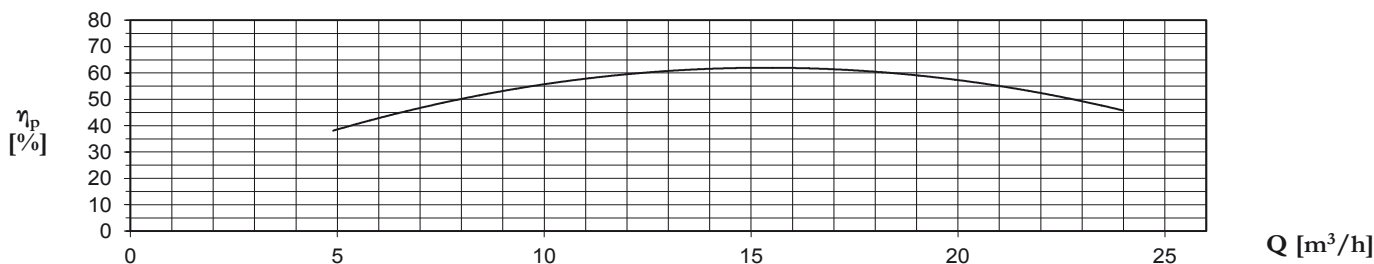
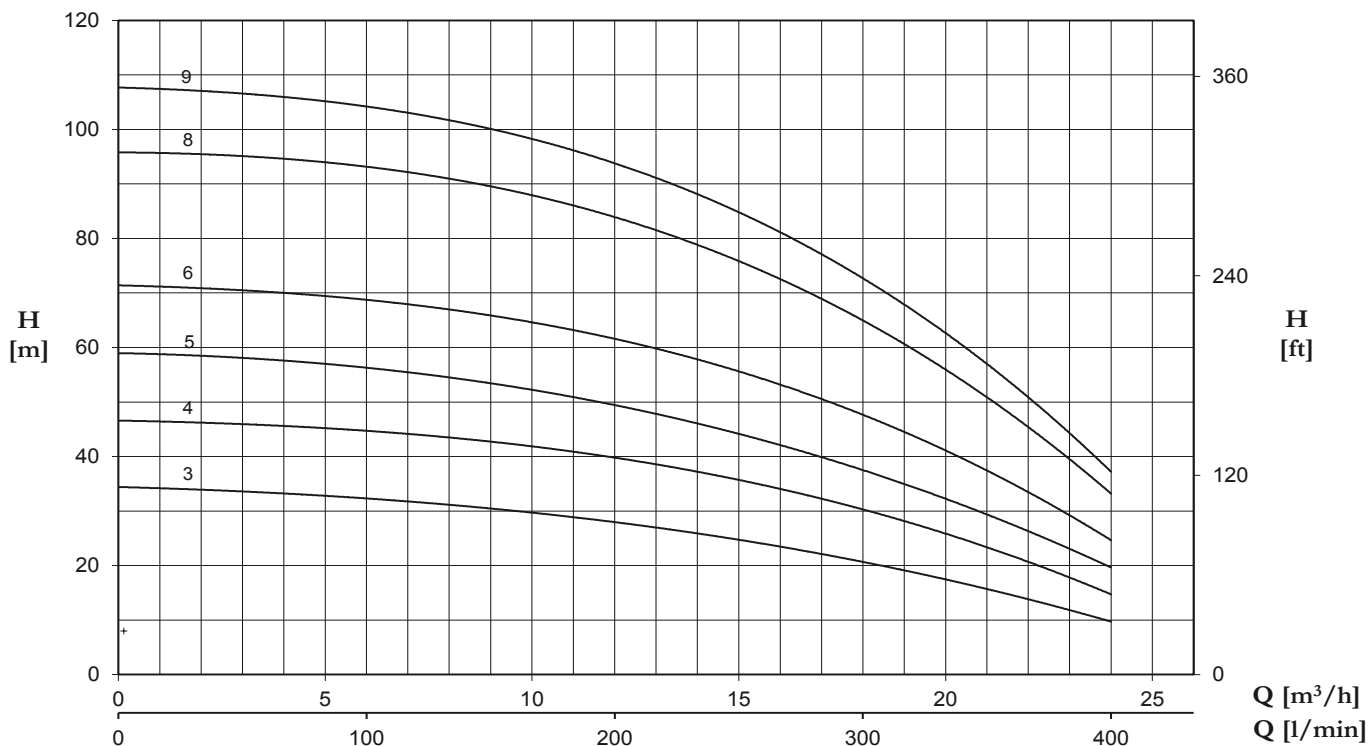

CARATTERISTICHE TECNICHE A 2900 GIRI / TECHNICAL PERFORMANCE AT 2900 RPM

Modello Model	P2		A	Q (m³/h -l/min)																
				0	6	7,2	8,4	9,6	10,8	12	13,2	14,4	15,6	16,8	18	19,2	20,4	21,6	22,8	24
3~	(HP)	(kW)	3x400V 50Hz	0	100	120	140	160	180	200	220	240	260	280	300	320	340	360	380	400
				H (m)																
U 18...-250/3T	2,5	1,85	4,3	34,5	32,0	31,6	30,9	30,1	29,1	28,1	26,8	25,5	24,1	22,5	20,7	18,7	16,5	14,4	12,2	10,0
U 18...-400/4T	4	3	5,5	46,8	44,2	43,7	43,1	42,4	41,3	40,1	38,6	36,9	35	32,6	30,1	27,4	24,5	21,5	18,4	15,2
U 18...-450/5T	4,5	3,31	6,6	59,1	55,9	55,1	54,1	52,8	51,3	49,7	47,7	45,5	43,0	40,3	37,3	34,3	30,9	27,4	23,9	19,8
U 18...-550/6T	5,5	4	8,7	71,6	68,2	67,4	66,5	65,4	63,8	61,9	59,7	57	54,2	51,1	47,6	43,7	39,5	34,7	29,9	25,2
U 18...-750/8T	7,5	5,5	10,7	96,1	92,6	91,5	90,1	88,5	86,6	84,4	81,6	78,3	74,5	69,8	64,7	59,1	53,3	46,9	40,5	34,3
U 18...-900/9T	9	6,6	12,8	108,0	103,6	102,3	100,8	99,0	96,9	94,1	91,1	87,5	83,0	78,3	72,6	66,2	59,6	52,6	45,5	38,3

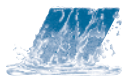

ULTRA V/L

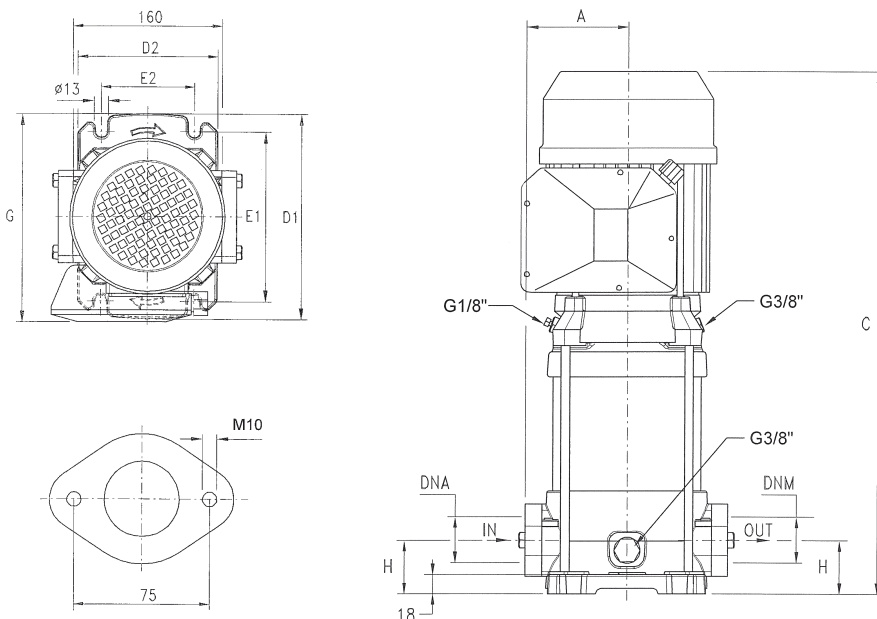

MODELLO POMPA PUMP'S MODEL	DIMENSIONI POMPA mm PUMP'S DIMENSIONS mm								PESO WEIGHT kg	DNA G	DNM G
	A	B	D1	D2	E1	E2	G	H			
U 3L-100/5	98	429	220	150	180	100	228	50	19	1" 1/4	1" 1/4
U 3L-120/6	98	453	220	150	180	100	228	50	19,3		
U 3L-150/7	98	507	220	150	180	100	228	50	22,6		
U 3L-180/8	98	531	220	150	180	100	228	50	23,6		
U 3L-200/9	98	555	220	150	180	100	228	50	25,5		
U 3L-250/10	98	579	220	150	180	100	228	50	26,1		
U 3L-280/11	98	M 648 T 603	220	150	180	100	M 236 T 228	50	27,3		
U 3L-300/12	98	M 672 T 627	220	150	180	100	M 236 T 228	50	28,4		

MODELLO POMPA PUMP'S MODEL	DIMENSIONI POMPA mm PUMP'S DIMENSIONS mm								PESO WEIGHT kg	DNA G	DNM G
	A	B	D1	D2	E1	E2	G	H			
U 5L-150/5	98	459	220	150	180	100	228	50	18,4	1" 1/4	1" 1/4
U 5L-180/6	98	483	220	150	180	100	228	50	20,7		
U 5L-200/7	98	507	220	150	180	100	228	50	21,6		
U 5L-250/8	98	531	220	150	180	100	228	50	23,4		
U 5L-280/9	98	M 600 T 555	220	150	180	100	M 236 T 228	50	24,0		
U 5L-300/10	98	M 624 T 529	220	150	180	100	M 236 T 228	50	26,3		
U 5L-350/11	98	648	220	150	180	100	236	50	26,7		

MODELLO POMPA PUMP'S MODEL	DIMENSIONI POMPA mm PUMP'S DIMENSIONS mm								PESO WEIGHT kg	DNA G	DNM G
	A	B	D1	D2	E1	E2	G	H			
U 7L-180/4	98	435	220	150	180	100	228	50	29,7	1" 1/4	1" 1/4
U 7L-250/5	98	459	220	150	180	100	228	50	21,0		
U 7L-300/6	98	M 528 T 483	220	150	180	100	M 236 T 228	50	23,0		
U 7L-350/7	98	552	220	150	180	100	236	50	25,5		
U 7L-400/8	98	576	220	150	180	100	236	50	25,9		
U 7L-450/9	98	633	220	150	180	100	251	50	28,8		
U 7L-550/10	98	657	220	150	180	100	251	50	33,3		

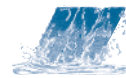

ELETTROPOMPE MULTIGIRANTI VERTICALI CON GIRANTE E DIFFUSORI NORYL®
NORYL® IMPELLERS AND DIFFUSERS VERTICAL MULTISTAGE ELECTRIC PUMPS

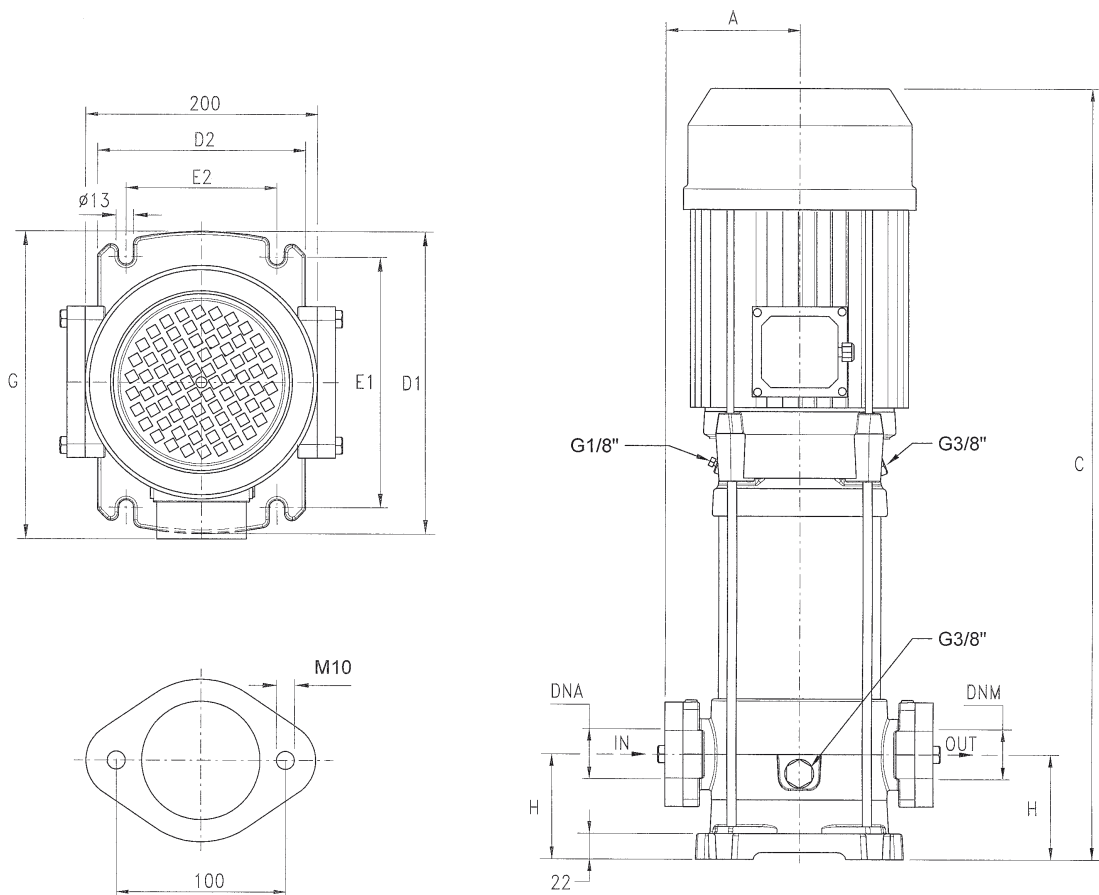

MODELLO POMPA PUMP'S MODEL	DIMENSIONI POMPA mm PUMP'S DIMENSIONS mm								PESO WEIGHT kg	DNA G	DNM G
	A	B	D1	D2	E1	E2	G	H			
U 9L-200/4	118	490	260	180	215	130	248	80	28,6	1" 1/2	1" 1/2
U 9L-250/5	118	520	260	180	215	130	248	80	29,2		
U 9L-300/6	118	M 595 T 550	260	180	215	130	M 256 T 248	80	31,8		
U 9L-400/7	118	625	260	180	215	130	256	80	35		
U 9L-450/8	118	688	260	180	215	130	271	80	38,6		
U 9L-500/9	118	718	260	180	215	130	271	80	39,1		
U 9L-550/10	118	748	260	180	215	130	271	80	42,1		

MODELLO POMPA PUMP'S MODEL	DIMENSIONI POMPA mm PUMP'S DIMENSIONS mm								PESO WEIGHT kg	DNA G	DNM G
	A	B	D1	D2	E1	E2	G	H			
U 18L-250/3	118	492	260	180	215	130	248	90	32,1	2"	2"
U 18L-400/4	118	575	260	180	215	130	256	90	34,2		
U 18L-450/5	118	646	260	180	215	130	271	90	38,1		
U 18L-550/6	118	683	260	180	215	130	271	90	41,5		
U 18L-750/8	118	804	260	180	215	130	280	90	50,4		
U 18L-900/9	118	842	260	180	215	130	280	90	50,3		

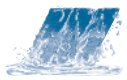

ULTRA V/L

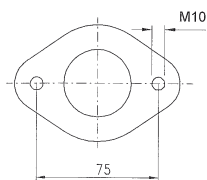
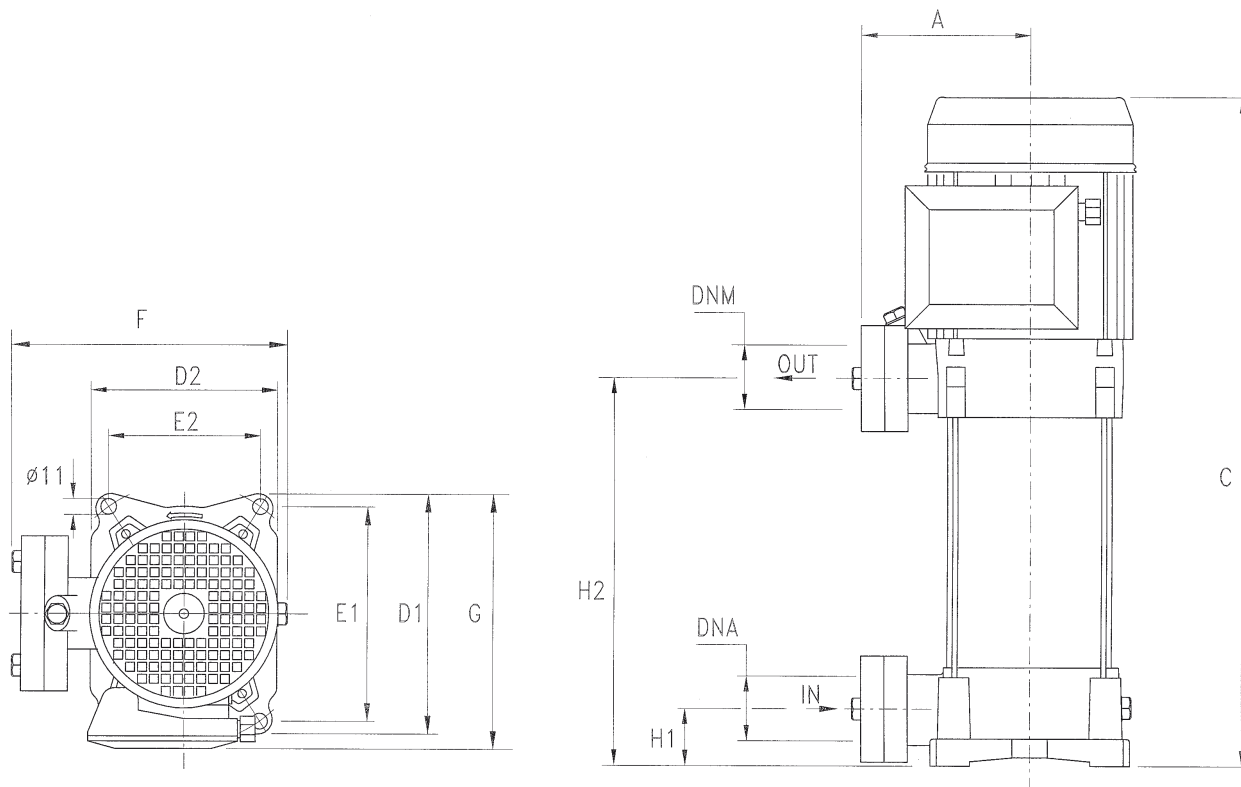

3-5-7

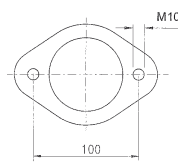

9-18

MODELLO POMPA PUMP'S MODEL	DIMENSIONI POMPA mm PUMP'S DIMENSIONS mm										PESO WEIGHT kg	DNA G	DNM G
	A	B	D1	D2	E1	E2	F	G	H1	H2			
U 3V-100/5	135	413	204	162	178,5	125	229	213	40	178	17,7	1" 1/4	1" 1/4
U 3V-120/6	135	437	204	162	178,5	125	229	213	40	202	18,1		
U 3V-150/7	135	491	204	162	178,5	125	229	220	40	226	21		
U 3V-180/8	135	515	204	162	178,5	125	229	220	40	250	21,8		
U 3V-200/9	135	539	204	162	178,5	125	229	220	40	274	23		
U 3V-250/10	135	563	204	162	178,5	125	229	220	40	298	23,5		
U 3V-280/11	135	M 632 T 587	204	162	178,5	125	229	M 228 T 220	40	322	24,7		
U 3V-300/12	135	M 656 T 611	204	162	178,5	125	229	M 228 T 220	40	346	26		

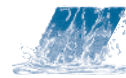

ELETTROPOMPE MULTIGIRANTI VERTICALI CON GIRANTE E DIFFUSORI NORYL®
 NORYL® IMPELLERS AND DIFFUSERS VERTICAL MULTISTAGE ELECTRIC PUMPS

MODELLO POMPA PUMP'S MODEL	DIMENSIONI POMPA mm PUMP'S DIMENSIONS mm										PESO WEIGHT kg	DNA G	DNM G
	A	B	D1	D2	E1	E2	F	G	H1	H2			
U 5V-120/4	135	389	204	162	178,5	125	229	213	40	178	18,4	1" 1/4	1" 1/2
U 5V-150/5	135	443	204	162	178,5	125	229	215	40	208,5	20,7		
U 5V-180/6	135	467	204	162	178,5	125	229	215	40	232,5	21,6		
U 5V-200/7	135	491	204	162	178,5	125	229	215	40	256,5	23,4		
U 5V-250/8	135	515	204	162	178,5	125	229	215	40	280,5	24,0		
U 5V-280/9	135	M 584 T 539	204	162	178,5	125	229	M 230 T 215	40	304,5	26,3		
U 5V-300/10	135	M 608 T 563	204	162	178,5	125	229	M 230 T 215	40	328,5	26,7		
U 5V-350/11	135	626	204	162	178,5	125	229	230	40	352,5	29,7		

MODELLO POMPA PUMP'S MODEL	DIMENSIONI POMPA mm PUMP'S DIMENSIONS mm										PESO WEIGHT kg	DNA G	DNM G
	A	B	D1	D2	E1	E2	F	G	H1	H2			
U 7V-180/4	135	419	204	162	178,5	125	229	215	40	184,5	21,0	1" 1/4	1" 1/4
U 7V-250/5	135	443	204	162	178,5	125	229	215	40	208,5	23,0		
U 7V-300/6	135	467	204	162	178,5	125	229	215	40	232,5	25,5		
U 7V-350/7	135	552	204	162	178,5	125	229	230	40	256,5	25,9		
U 7V-400/8	135	576	204	162	178,5	125	229	230	40	280,5	28,8		
U 7V-450/9	135	633	204	162	178,5	125	235	250	40	304,5	33,3		
U 7V-550/10	135	657	204	162	178,5	125	235	250	40	328,5	36,3		

MODELLO POMPA PUMP'S MODEL	DIMENSIONI POMPA mm PUMP'S DIMENSIONS mm										PESO WEIGHT kg	DNA G	DNM G
	A	B	D1	D2	E1	E2	F	G	H1	H2			
U 9V-200/4	135	443	204	162	178,5	125	229	215	40	208,5	22,6	1" 1/2	1" 1/4
U 9V-250/5	135	473	204	162	178,5	125	229	215	40	238,5	23,2		
U 9V-300/6	135	M 548 T 503	204	162	178,5	125	229	M 230 T 215	40	268,5	25,9		
U 9V-400/7	135	578	204	162	178,5	125	229	230	40	298,5	28,8		
U 9V-450/8	135	641	204	162	178,5	125	235	250	40	328,5	33,2		
U 9V-500/9	135	671	204	162	178,5	125	235	250	40	358,5	33,7		
U 9V-550/10	135	701	204	162	178,5	125	235	250	40	388,5	36,7		

MODELLO POMPA PUMP'S MODEL	DIMENSIONI POMPA mm PUMP'S DIMENSIONS mm										PESO WEIGHT kg	DNA G	DNM G
	A	B	D1	D2	E1	E2	F	G	H1	H2			
U 18V-250/3T	135	451	204	162	178,5	125	229	215	50	213,5	27,2	2"	1" 1/2
U 18V-400/4T	135	534	204	162	178,5	125	229	230	50	251	29,2		
U 18V-450/5T	135	605	204	162	178,5	125	235	250	50	288,5	33,9		
U 18V-550/6T	135	642	204	162	178,5	125	235	250	50	326	37,1		
U 18V-750/8T	135	763	204	162	178,5	125	255	253	50	401	46,6		
U 18V-900/9T	135	801	204	162	178,5	125	255	253	50	439	46,6		